

Temperature Controller

1/16 DIN - 48 x 48



ASCON spa

ISO 9001
Certified

M3 line

User manual • M.I.U.M3 - 4/03.01 • Cod. J30-478-1AM3 IE



ASCON spa
20021 Bollate
(Milano) Italy
via Falzarego, 9/11
Tel. +39 02 333 371
Fax +39 02 350 4243
<http://www.ascon.it>
e-mail sales@ascon.it



Temperature Controller

1/16 DIN - 48 x 48

M3 line

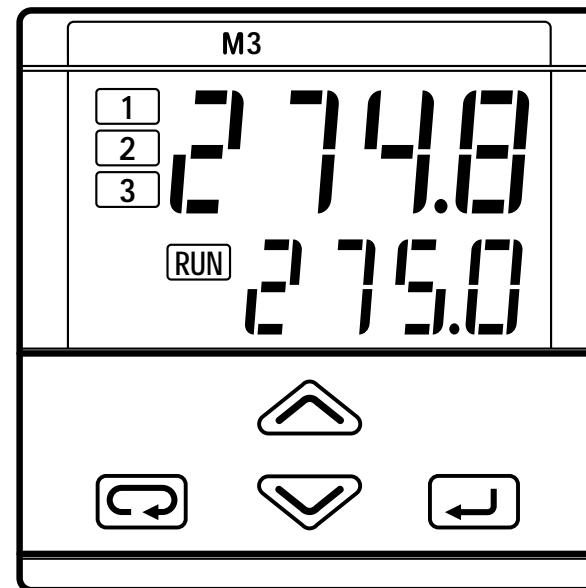



NOTES

ON ELECTRIC SAFETY AND ELECTROMAGNETIC COMPATIBILITY.

Please, read carefully these instructions before proceeding with the installation of the controller.

Class II instrument, real panel mounting.

This controller has been designed with compliance to:

Regulations on electrical apparatus (appliance, systems and installations) according to the European Community directive 73/23 CEE amended by the European Community directive 93/68 CEE and the Regulations on the essential protection requirements in electrical apparatus EN 61010-1 (IEC 1010 - 1) : 90 +A1:92 + A2:95.

Regulations on Electromagnetic Compatibility according to the European Community directive n089/336/CEE, amended by the European Community directive n° 92/31/CEE and the following regulations:

Regulations on RF emissions

EN50081 - 1 residential environments

EN50081 - 2 industrial environments

Regulation on RF immunity

EN500082-2 industrial equipment and system

It is important to understand that it's responsibility of the installer to ensure the compliance of the regulations on safety requirements and EMC.

The device has no user serviceable parts and requires special equipment and specialised engineers. Therefore, a repair can be hardly carried on directly by the user. For this purpose, the manufacturer provides technical assistance and the repair service for its Customers.

Please, contact your nearest Agent for further information.

All the information and warnings about safety and electromagnetic compatibility are marked with the CE sign, at the side of the note.

TABLE OF CONTENTS

1	INSTALLATION	Page	4
2	ELECTRICAL CONNECTIONS	Page	8
3	PRODUCT CODING	Page	16
4	OPERATIONS	Page	20
5	AUTOMATIC TUNE	Page	38
6	SPECIAL FUNCTIONS	Page	39
7	TECHNICAL SPECIFICATIONS	Page	44

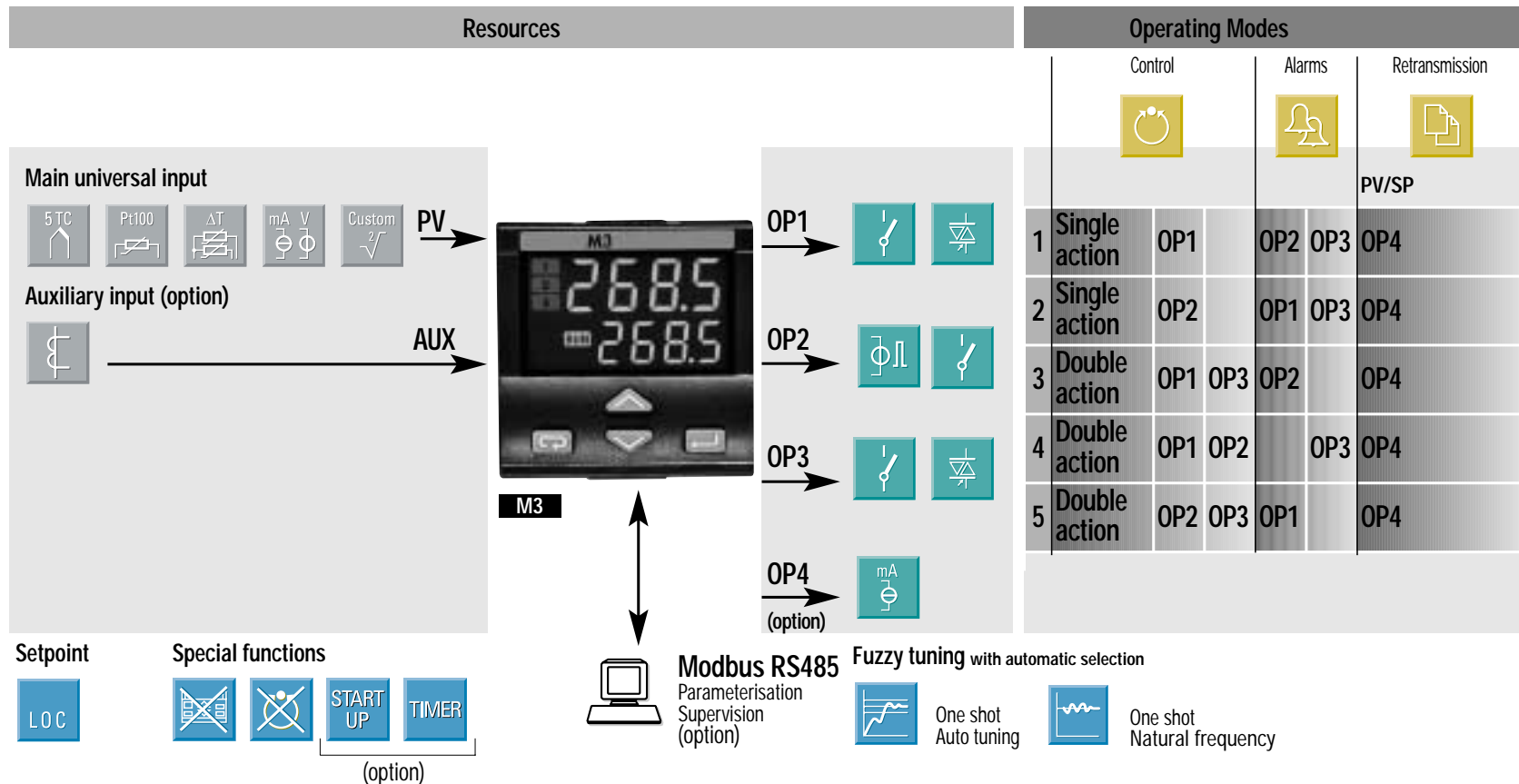

1 ■ INSTALLATION

Installation must only be carried out by qualified personnel.

Before proceeding with the installation of this controller, follow the instructions illustrated in this manual and, particularly the installation precautions marked with the  symbol, related to the European Community directive on electrical protection and electromagnetic compatibility.



To prevent hands or metal touching parts that may be electrically live, **the controllers must be installed in an enclosure and/or in a cubicle.**

1.1 GENERAL DESCRIPTION

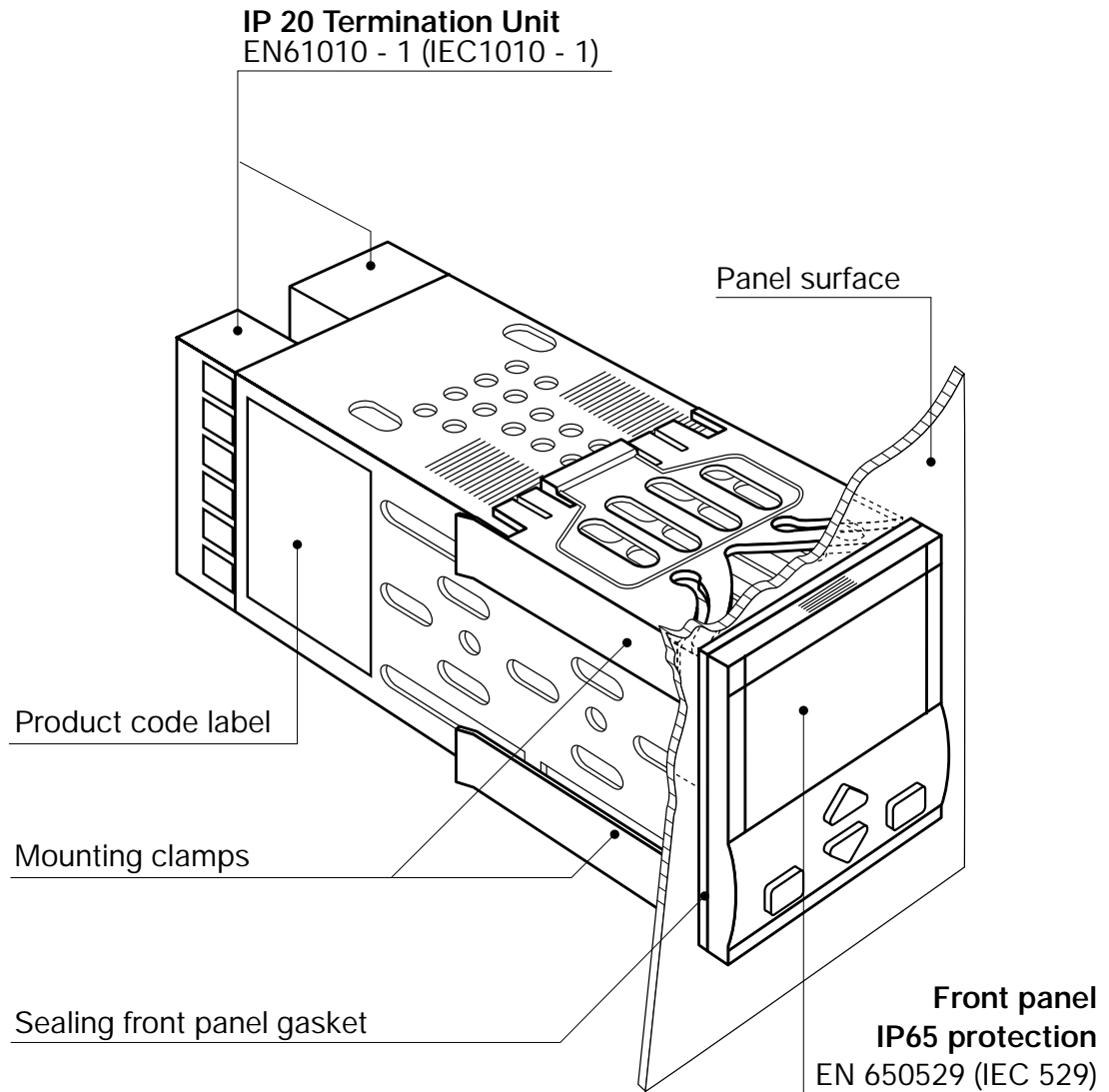

1.2 DIMENSIONAL DETAILS

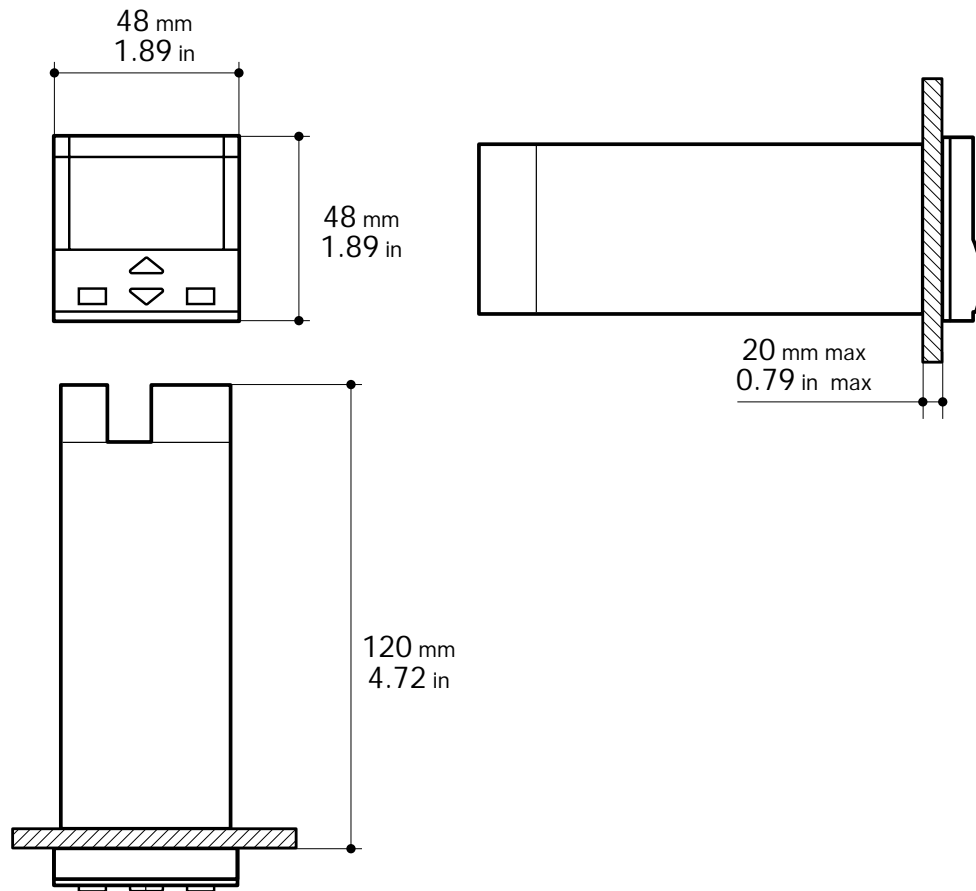



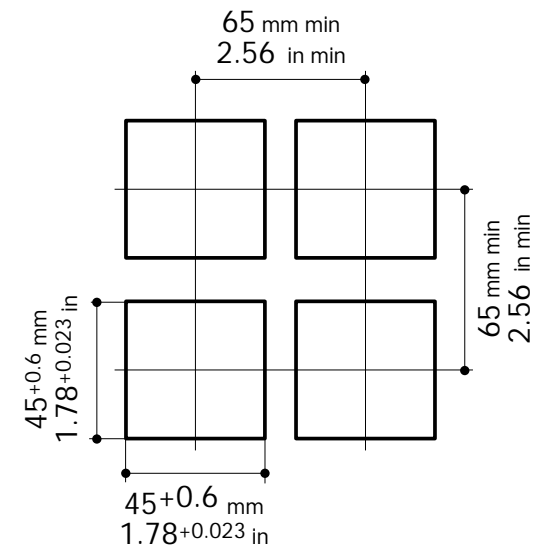

1.3 PANEL CUT-OUT





1.4 ENVIRONMENTAL RATINGS



Operating conditions	
 2000	Altitude up to 2000 m
 °C	Temperature 0...50°C
%Rh	Relative humidity 5...95 % non-condensing

Special conditions	Suggestions
 2000	Altitude > 2000 m Use 24V~ supply version
 °C	Temperature >50°C Use forced air ventilation
%Rh	Humidity > 95 % Warm up
	Conducting atmosphere Use filter

Forbidden Conditions 	
	Corrosive atmosphere
	Explosive atmosphere

1.5 PANEL MOUNTING [1]

1.5.1 INSERT THE INSTRUMENT

- 1 Prepare panel cut-out
- 2 Check front panel gasket position
- 3 Insert the instrument through the cut-out

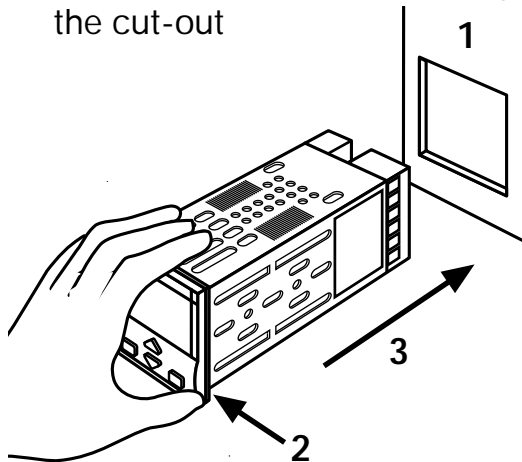

UL note

[1] For Use on a Flat Surface of a Type 2 and Type 3 'raintight' Enclosure.

1.5.2 INSTALLATION SECURING

- 1 Fit the mounting clamps
- 2 Push the mounting clamps towards the panel surface to secure the instrument

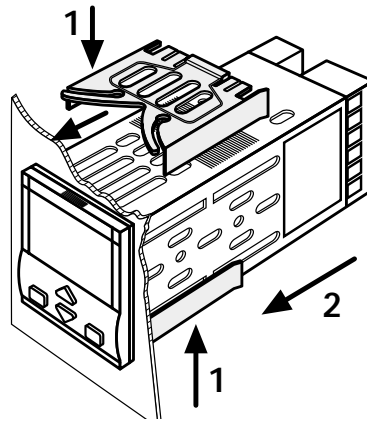

1.5.3 CLAMPS REMOVING

- 1 Insert the screwdriver in the clips of the clamps
- 2 Rotate the screwdriver

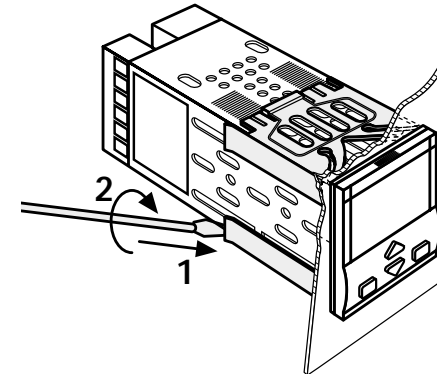

1.5.4 INSTRUMENT UNPLUGGING



- 1 Push and
- 2 pull to remove the instrument

Electrostatic discharges can damage the instrument
 Before removing the instrument the operator must discharge himself to ground

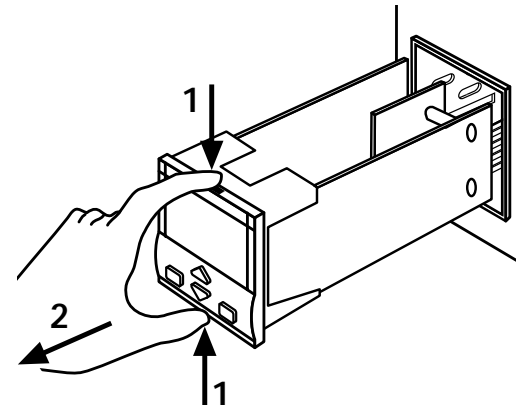
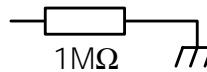

2 ELECTRICAL CONNECTIONS

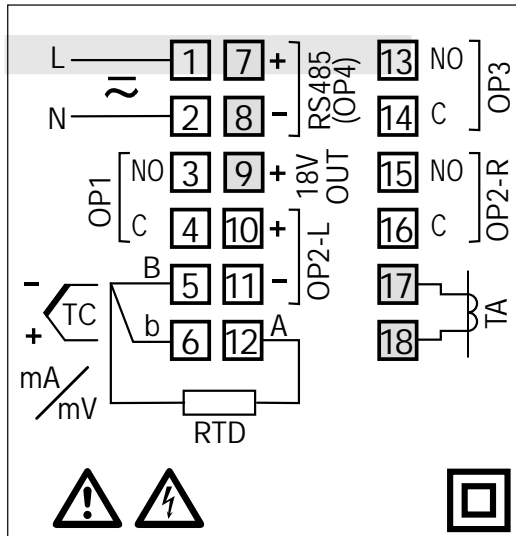

2.1 TERMINATION UNIT [1]

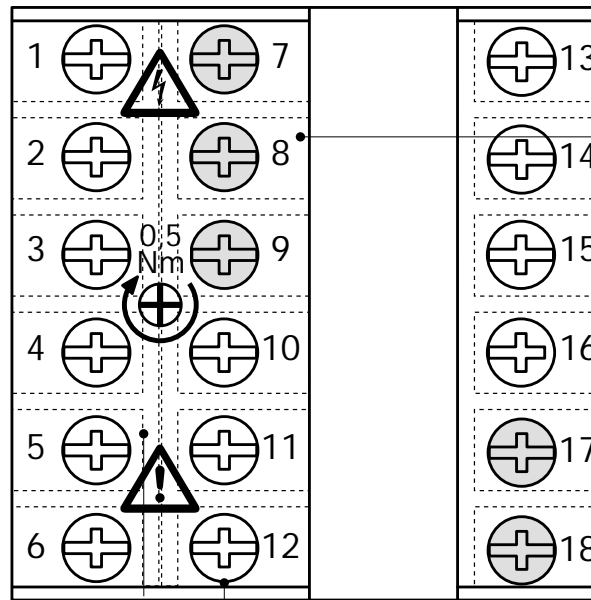



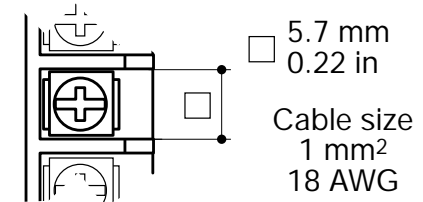

Rear terminal cover





UL note

[1] Use 60/70 °C copper (Cu) conductor only.

-  18 screw terminals
-  Option terminals
-  Holding screw 0.5 Nm
-  Positive screw driver PH1
-  Negative screw driver 0,8 x 4 mm

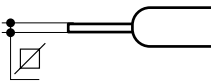
Terminals

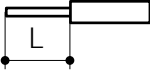
-  Pin connector
∅ 1.4 mm
0.055 in max
-  Fork-shape
AMP 165004
∅ 5.5 mm - 0.21 in
-  Stripped wire
L 5.5 mm - 0.21 in

PRECAUTIONS 

Despite the fact that the instrument has been designed to work in an harsh and noisy environmental (level IV of the industrial standard IEC 801-4), it is recommended to follow the following suggestions.



All the wiring must comply with the local regulations.

The supply wiring should be routed away from the power cables. Avoid to use electromagnetic contactors, power Relays and high power motors nearby. Avoid power units nearby, especially if controlled in phase angle

Keep the low level sensor input wires away from the power lines and the output cables. If this is not achievable, use shielded cables on the sensor input, with the shield connected to earth.

2.2 PRECAUTIONS AND ADVISED CONDUCTOR COURSE 

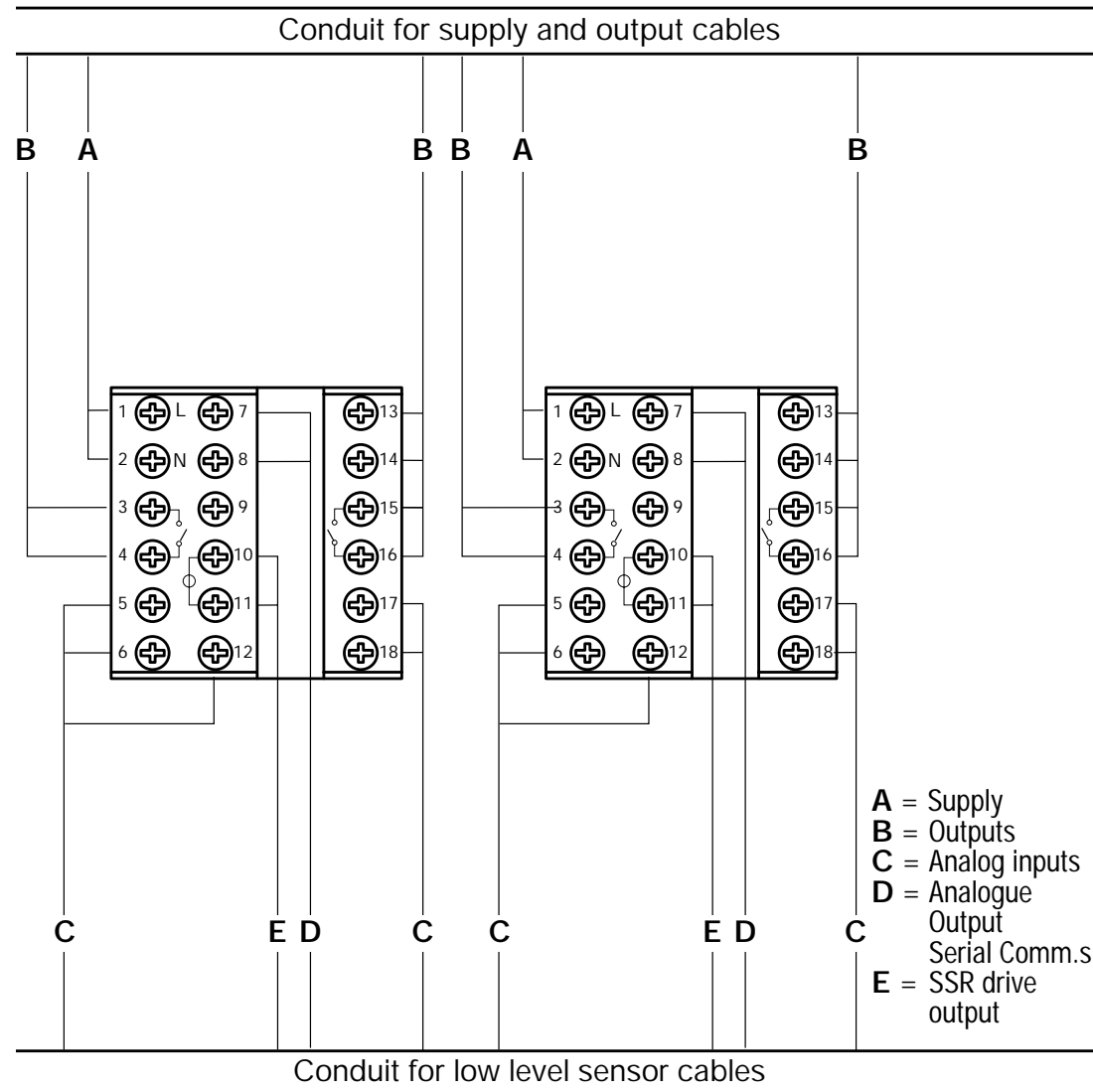

2.3 EXAMPLE OF WIRING DIAGRAM (HEAT COOL CONTROL)

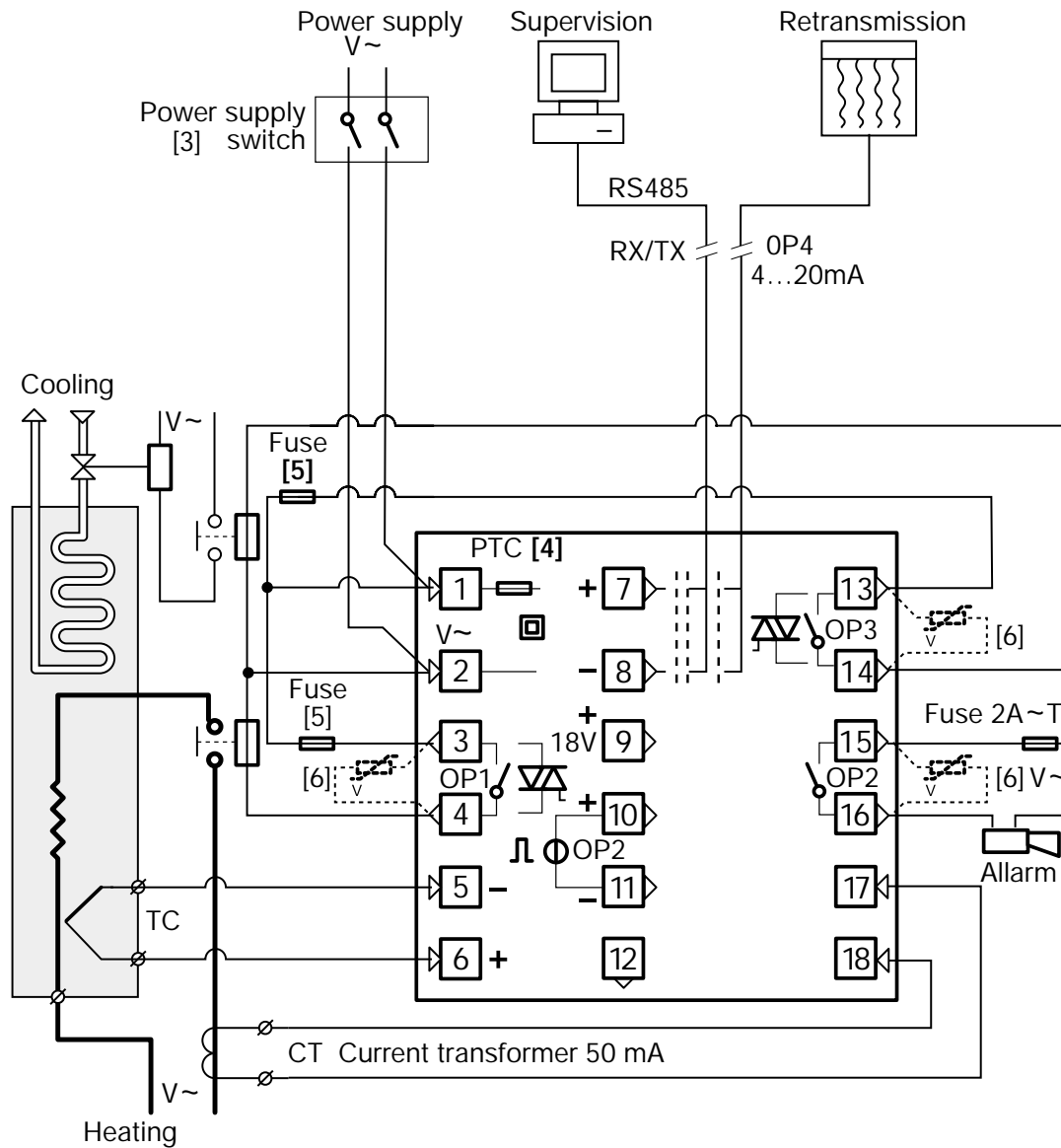

Notes:

- 1] Make sure that the power supply voltage is the same indicated on the instrument.
- 2] Switch on the power supply only after that all the electrical connections have been completed.
- 3] In accordance with the safety regulations, the power supply switch shall bring the identification of the relevant instrument. The power supply switch shall be easily accessible from the operator.
- 4] The instrument is is PTC protected. In case of failure it is suggested to return the instrument to the manufacturer for repair.
- 5] To protect the instrument internal circuits use:
 - 2 A ~ T fuses for Relay outputs
 - 1 A ~ T fuses for Triac outputs
- 6] Relay contacts are already protected with varistors.

Only in case of 24 V ~ inductive loads, use model A51-065-30D7 varistors (on request)

2.3.1 POWER SUPPLY 

Switching power supply with multiple isolation and internal PTC

- Standard version:
nominal voltage:
100 - 240V~ (- 15% + 10%)
Frequency 50/60Hz
- Low Voltage version:
Nominal voltage:
24V~ (- 25% + 12%)
Frequency 50/60Hz
or 24V- (- 15% + 25%)
- Power consumption 2.6W max

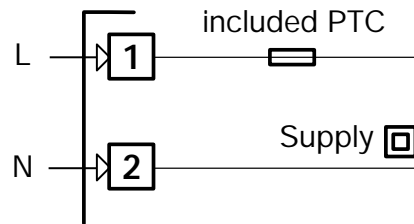

2.3.2 PV CONTROL INPUT 

A For L-J-K-S-T thermocouple type

- Connect the wires with the polarity as shown
- Use always compensation cable of the correct type for the thermocouple used
- The shield, if present, must be connected to a proper earth.

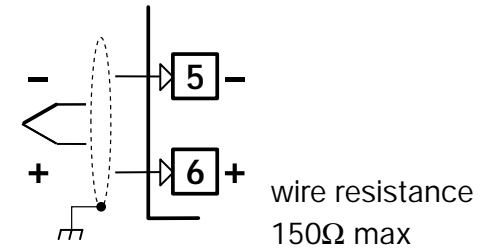

B For Pt100 resistance thermometer

- If a 3 wires system is used, use always cables of the same diameter (1mm² min.) (line 20 Ω/lead maximum resistance)
- When using a 2 wires system, use always cables of the same diameter (1,5mm² min.) and put a jumper between terminals 5 and 6

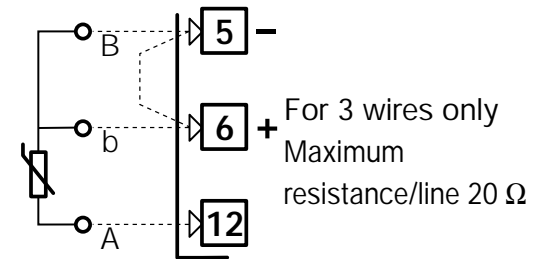

C For ΔT (2x RTD Pt100) Special

-  When the distance between the controller and the sensor is 15 mt. using a cable of 1.5 mm² diameter, produces an error on the measure of 1°C (1°F).

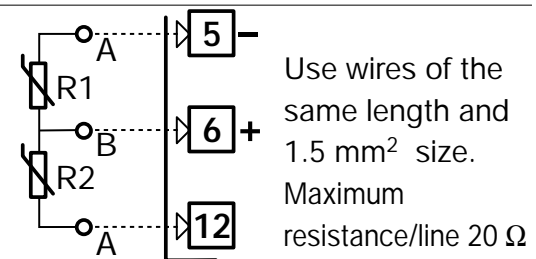

R1 + R2 must be <320Ω

2.3.2 PV CONTROL INPUT



D For mA, mV

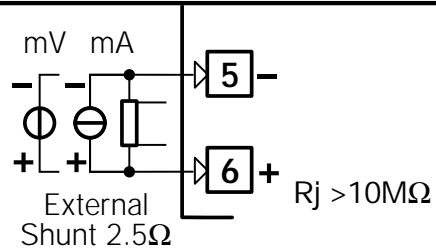

D1 With 2 wires transducer

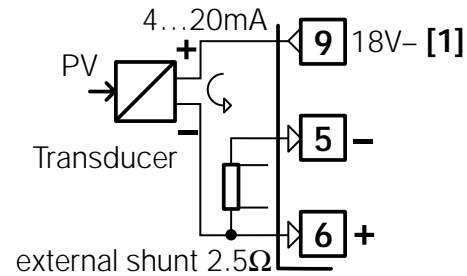

D2 With 3 wires transducer

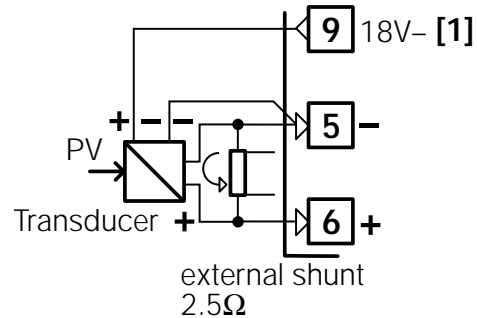

[1] Auxiliary power supply for external transmitter 18V- ±20% /30mA max. without short circuit protection

2.3.3 AUXILIARY INPUT (option)



For current transformer CT

Not isolated

For the measure of the load current (see page 34)

- Primary coil 10A...100A
- Secondary coil 50mA default
100mA jumper selectable

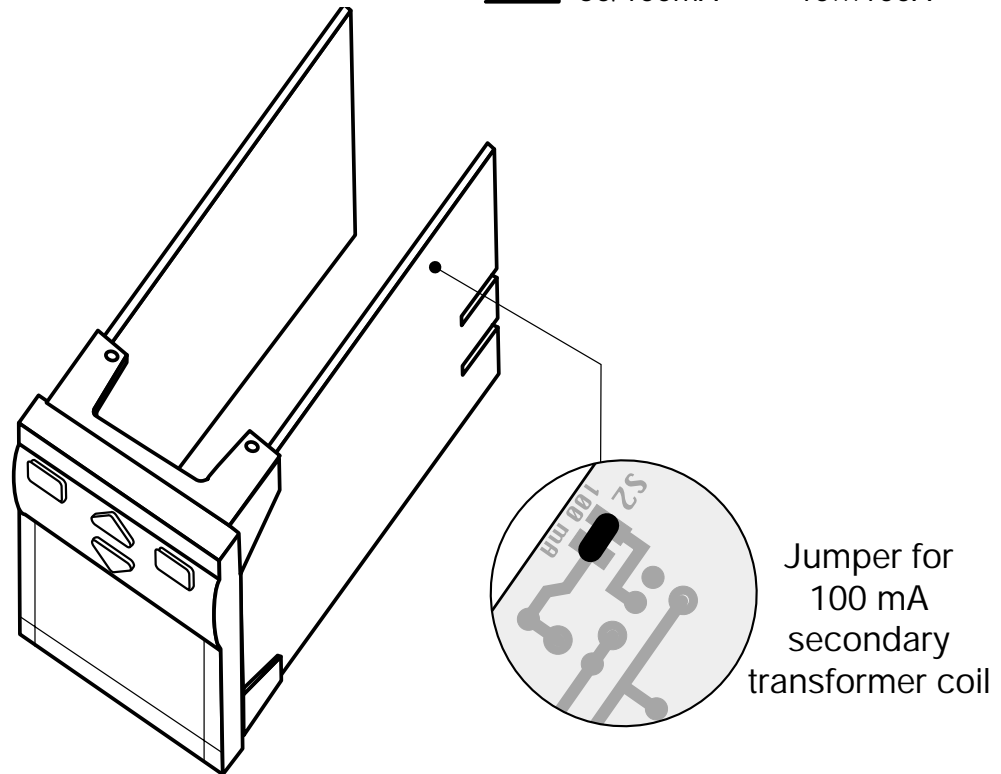
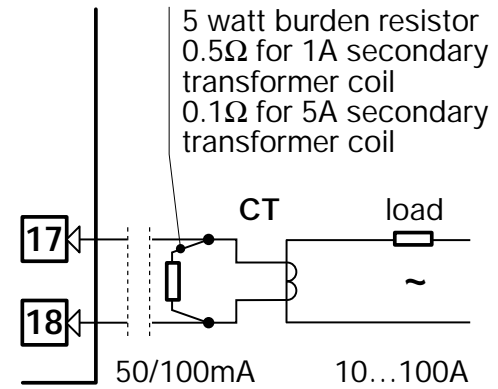

Jumper for 100 mA secondary transformer coil

2.3.4 OP1 - OP2 - OP3 OUTPUTS



The functionality associated to each of the OP1, OP2 and OP3 input is defined during the configuration of the instrument index **L** (see page 18).
The suggested combinations are:

		Control		Alarms	
				AL2	AL3
A	Single action	OP1 Heat		OP2-R	OP3
B	Single action	OP2-L Heat		OP1	OP3
C	Double action	OP1 Heat	OP3 Cool	OP2-R [1]	
D	Double action	OP1 Heat	OP2-L Cool		OP3 [1]
E	Double action	OP2-L Heat	OP3 Cool	OP1 [1]	

OP1 - OP3	Relay or Triac output
OP2 - L	SSR drive output
OP2 - R	Relay output

Note

[1] With heat / cool control AL2 and AL3 share in or mode the same output (the free one)

OP2 output can be Relay (Std) or SSR drive.

The “jumper” on the auxiliary board selects the output type:

Link Pins 1-2 for OP2-Relay

Link Pins 2-3 for OP2-SSR drive

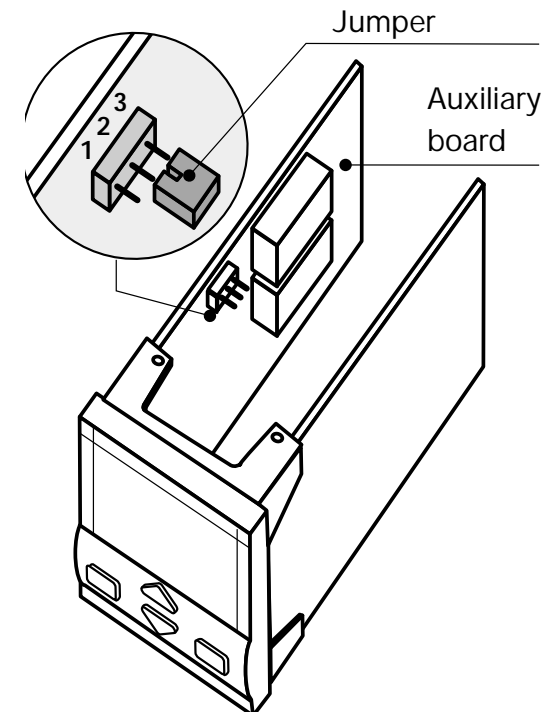

2 - Electrical connections

2.3.4-A SINGLE ACTION

RELAY (TRIAC)

CONTROL OUTPUT

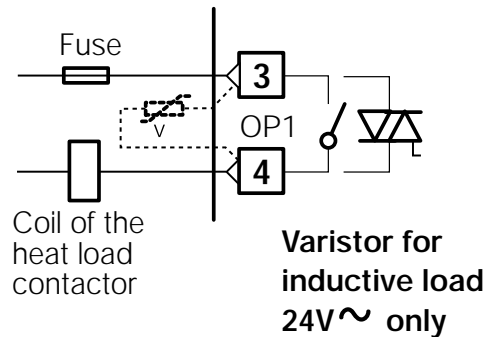

2.3.4-B SINGLE ACTION

SSR DRIVE CONTROL

OUTPUT

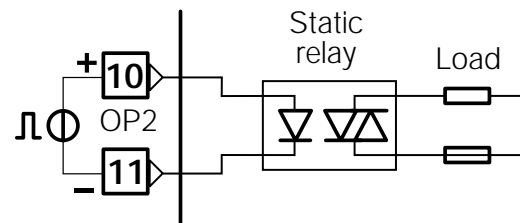

Relay output

- SPST Relay N.O., 2A/250 V~ for resistive load, fuse 2A~ T

Triac output

- N.O. contact for resistive load of up to 1A/250 V~ max, fuse 1A ~ T

SSR drive output not isolated

- 0...5V-, ±20%, 30 mA max

2.3.4-C DOUBLE ACTION

RELAY (TRIAC)/RELAY (TRIAC) CONTROL OUTPUT

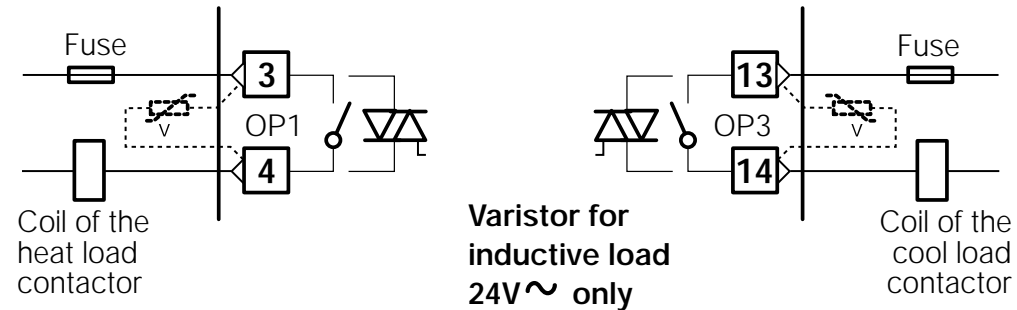

2.3.4-D DOUBLE ACTION

RELAY (TRIAC)/SSR DRIVE CONTROL OUTPUT

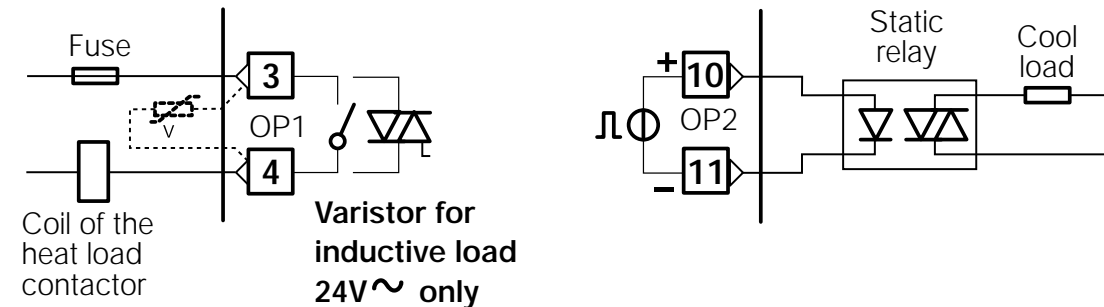

2.3.4-E DOUBLE ACTION

SSR DRIVE/RELAY (TRIAC) CONTROL OUTPUT

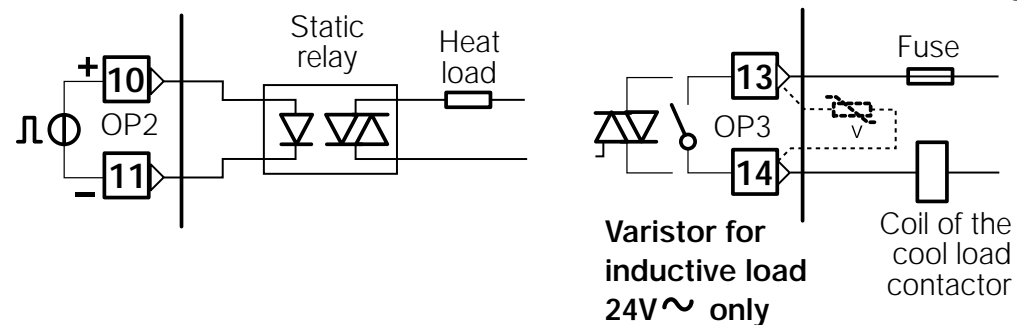

2.3.5 ALARMS OUTPUTS

 The outputs OP1, OP2 and OP3, can be used as alarm outputs only if they are not used as control outputs.

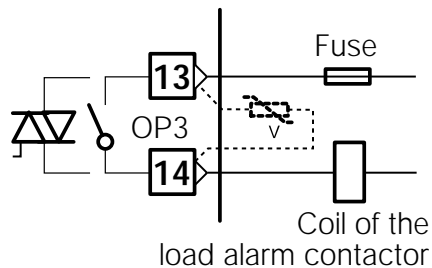
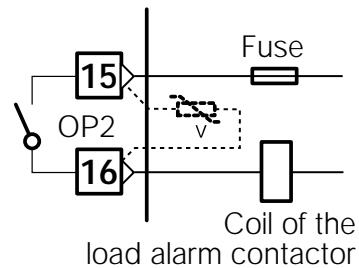
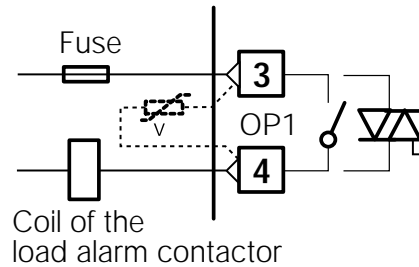

**Varistor for inductive load
24V~ only**

2.3.6 OP4 OUTPUT (option)

PV or SP retransmission

- Galvanic isolation
500V~ /1 min
- 0/4...20mA, (750Ω or 15V- max)

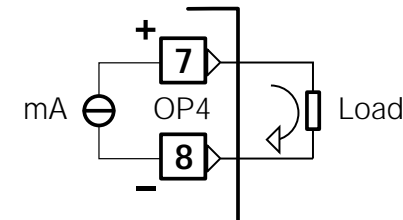

2.3.7 SERIAL COMMUNICATIONS (option)

- Galvanic isolation 500V~ /1 min
- Compliance to the EIA RS485 standard for Modbus/Jbus

 Please, read:
gammadue® and **deltadue®**
controller series serial communication and configuration

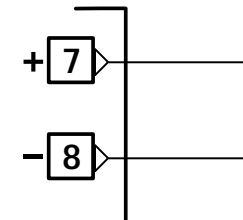

3 PRODUCT CODING

The complete code is shown on the instrument label. The informations about product coding are accessible from the front panel by mean of a particular procedure described at section 4.2.2 page 21

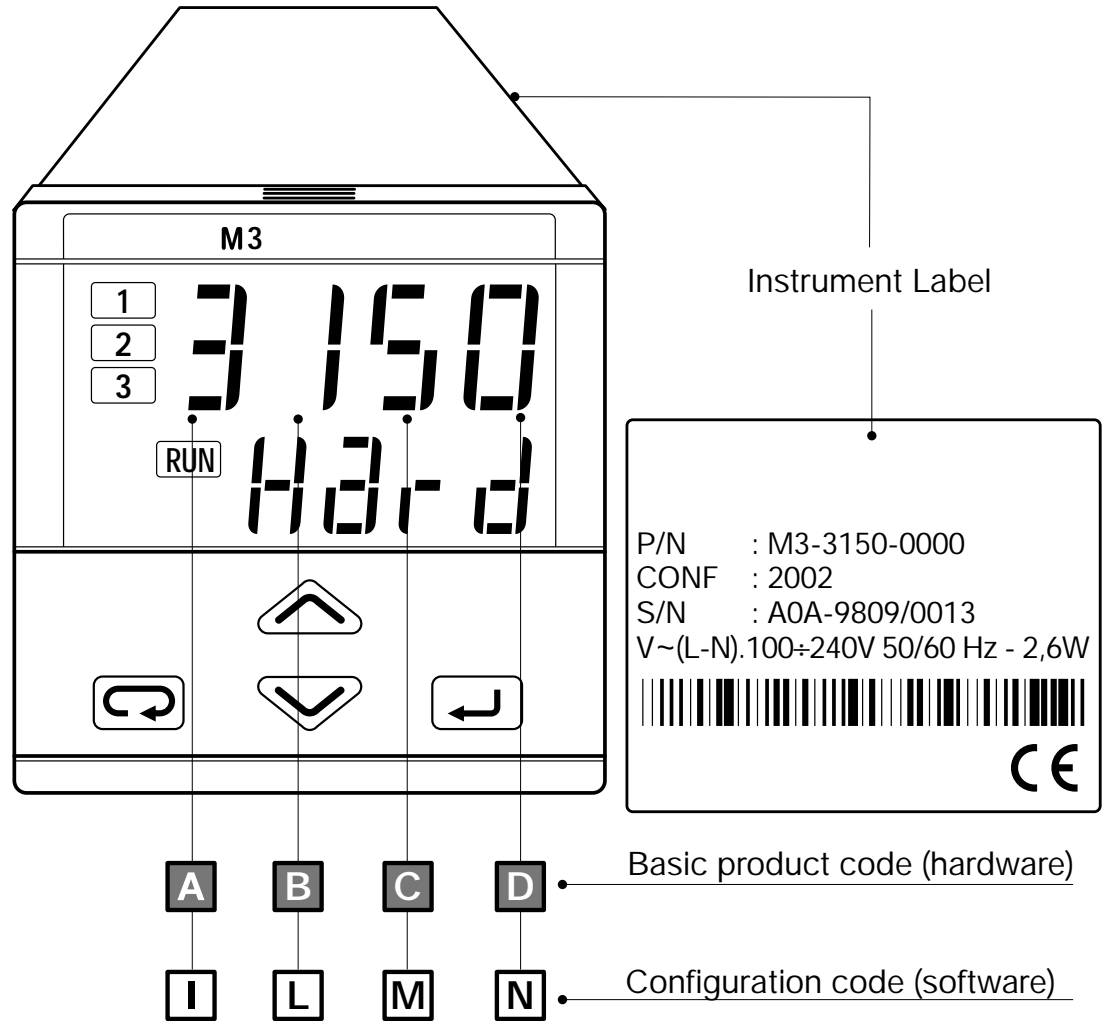

3.1 MODEL CODE

The product code indicates the specific hardware configuration of the instrument, that can be modified by specialized engineers only.

Model: **Line** **M 3** **Basic** **A B C D** - **Accessories** **E F G 0** / **Configur.** **I L M N**

Line	M 3
-------------	------------

Power supply	A
100 - 240V~ (- 15% + 10%)	3
24V~ (- 25% + 12%) or 24V- (- 15% + 25%)	5

OP1 - OP3 Outputs	B
Relay - Relay	1
Relay - Triac	2
Triac - Relay	4
Triac - Triac	5

Serial Communications	Options	C	D
Not fitted	None	0	0
	Current transformer input (CT)	0	3
	Transmitter Power Supply (P.S.)	0	6
	Transmitter P.S. + Retransmis.	0	7
	Transmitter P.S. + CT	0	8
	Transmitter P.S. + Retransmis. + CT	0	9
RS485 Modbus/Jbus protocol	None	5	0
	Transmitter Power Supply	5	6
	Transmitter P.S. + CT	5	8

Special functions	E
Not fitted	0
Start up + Timer	2

User manual	F
Italian/English (std)	0
French/English	1
German/English	2
Spanish/English	3

Front panel colour	G
Dark (std)	0
Beige	1

3.2 CONFIGURATION CODING

The configuration code consists of 4 digits that identify the operating characteristic of the controller, as chosen by the user.

Section 4.6 at page 35 reports the instructions how to set a new configuration code.

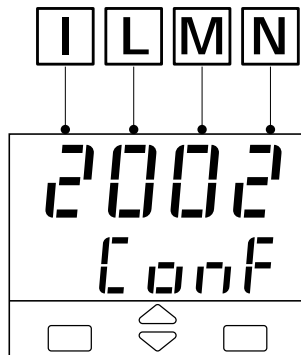

The configuration code can be displayed on the front panel, following the instructions at page 21 section 4.2.2.

Input type and range			I
TR Pt100 IEC751	-99.9...300.0 °C	-99.9...572.0 °F	0
TR Pt100 IEC751	-200...600 °C	-328...1112 °F	1
TC L Fe-Const DIN43710	0...600 °C	32...1112 °F	2
TC J Fe-Cu45% Ni IEC584	0...600 °C	32...1112 °F	3
TC T Cu-CuNi	-200 ...400 °C	-328...752 °F	4
TC K Chromel -Alumel IEC584	0...1200 °C	32...2192 °F	5
TC S Pt10%Rh-Pt IEC584	0...1600 °C	32...2912 °F	6
DC input 0...50 mV, linear	Engineering units		7
DC input 10...50 mV, linear	Engineering units		8
Custom input and range [1]			9

Note

[1] For instance, other thermocouples types, ΔT (with 2 PT 100), custom linearisation etc.

Control mode	Output configuration	L
PID	Control OP1 / alarm AL2 on OP2	0
	Control OP2 / alarm AL2 on OP1	1
On - Off	Control OP1 / alarm AL2 on OP2	2
	Control OP2 / alarm AL2 on OP1	3
Heat/Cool action	Control OP1- OP3 / alarm AL2 on OP2	6
	Control OP1- OP2 / alarm AL2 on OP3	7
	Control OP2- OP3 / alarm AL2 on OP1	8

Control action type		M
Reverse (single action)	Linear Cool (Heat/Cool double action)	0
Direct (single action)	On-Off Cool (Heat/Cool double action)	1



If, when the controller is powered up for the first time, the display shows the following message

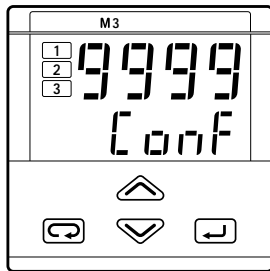

it means that the controller has not been configured yet.

The controller remains in stand-by until the configuration code is set correctly (see chapter 4.6 page 35).

Alarm 2 type and function		N
Disabled		0
Sensor break alarm / Loop Break Alarm		1
Absolute	active high	2
	active low	3
Deviation	active high	4
	active low	5
Band	active out	6
	active in	7
Heater break by CT [2]	active during ON output state	8
	active during OFF output state	9

Alarm 3 type and function		O
Disabled or used by Timer		0
Sensor break alarm / Loop Break Alarm		1
Absolute	active high	2
	active low	3
Deviation	active high	4
	active low	5
Band	active out	6
	active in	7
Heater break by CT [2]	active during ON output state	8
	active during OFF output state	9

For alarm 3 type and function [0 0 0] see page 36

Note

[2] Only with CT options.

4 OPERATIONS

4.1.A KEYS FUNCTIONS AND DISPLAY IN OPERATOR MODE

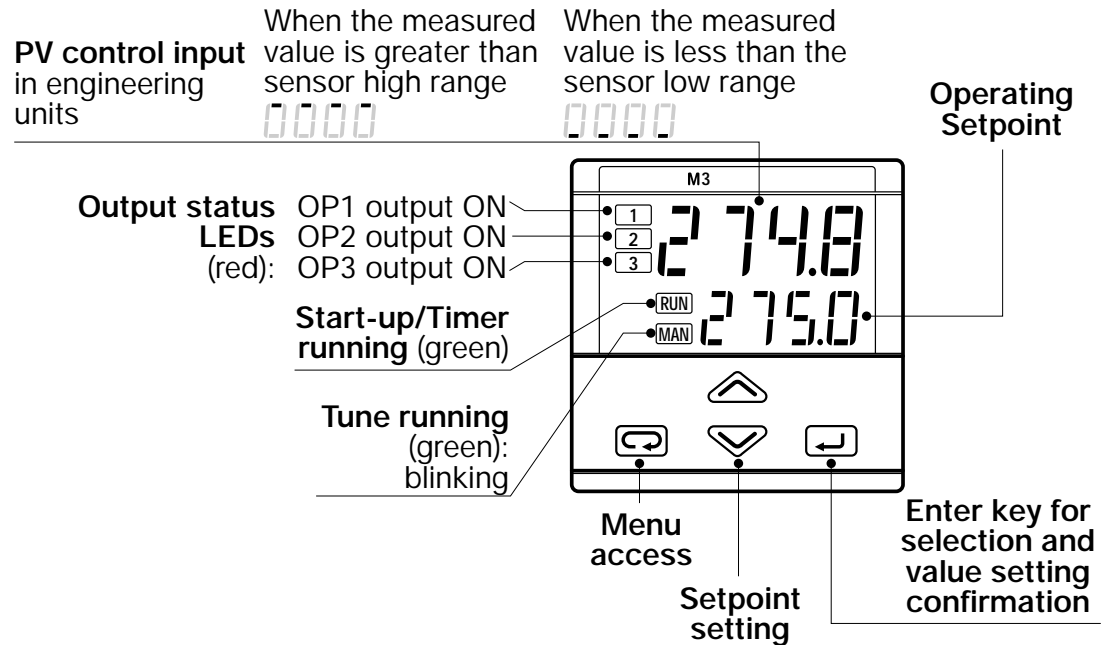

4.1.B KEYS FUNCTIONS AND DISPLAY IN PROGRAMMING MODE

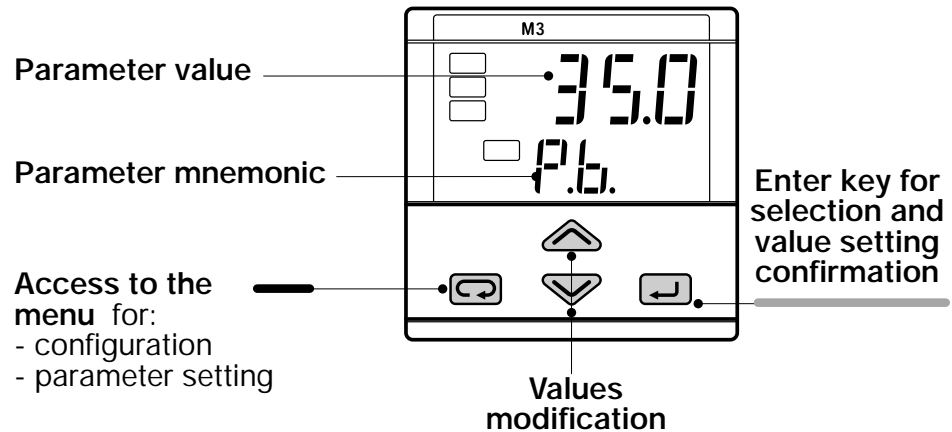

4.2 DISPLAY

During the operation, the parameters values cannot be modified by the user

Note

[1] See table page 37

[2] This display is not presented if the instrument has been configured as an On - Off controller

[3] Value in Ampere. Only with CT option (see page 34)

[4] Only with Timer option selected (see page 41)

4.2.1 OF THE PROCESS VARIABLES

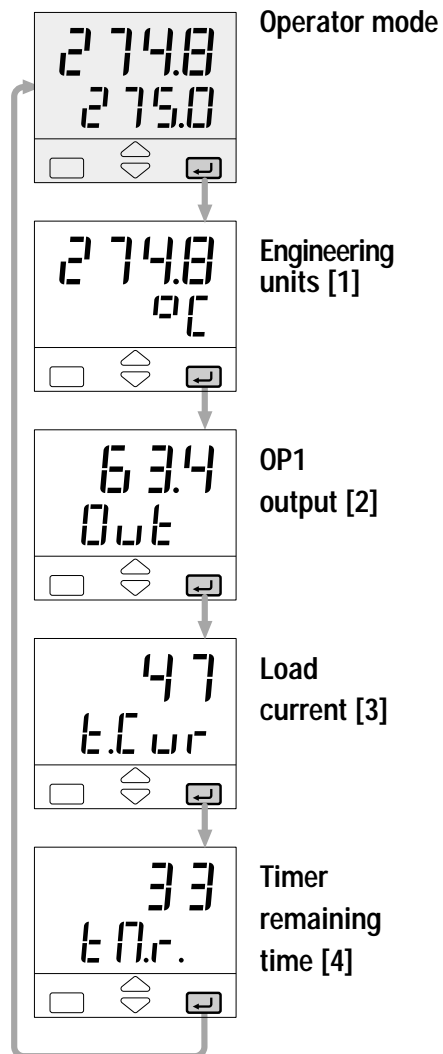

4.2.2 OF THE CONFIGURATION CODES

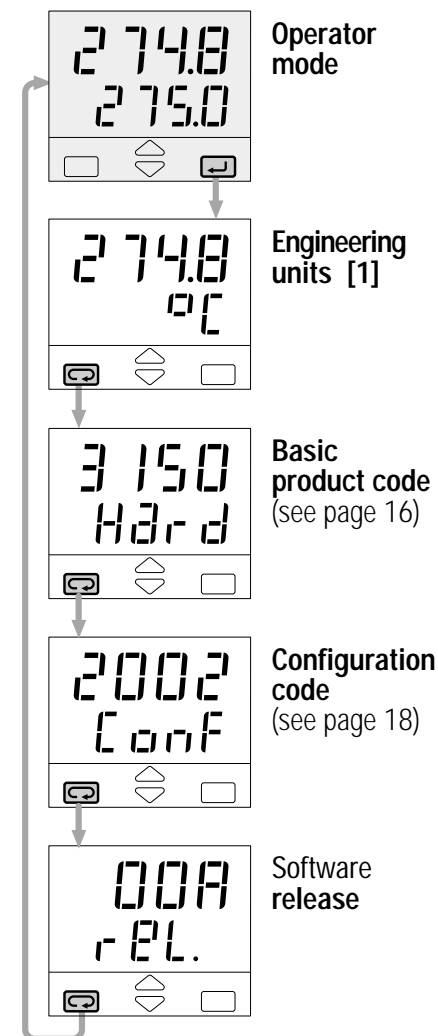



Example:



M3 - 3150 - 2002 / Release 00A

4.3 PARAMETER SETTING



4.3.1 NUMERIC ENTRY

(i.e. the modification of the Setpoint value from 275.0 to 240.0)

Press  or  momentarily to change the value of 1 unit every push

Continued pressing of  or  changes the value, at rate that doubles every second. Releasing the button the rate of change decreases.

In any case the change of the value stops when it has reached the max/min limit set for the parameter.



In case of Setpoint modification: press  or  once to display the local Setpoint instead of working Setpoint.

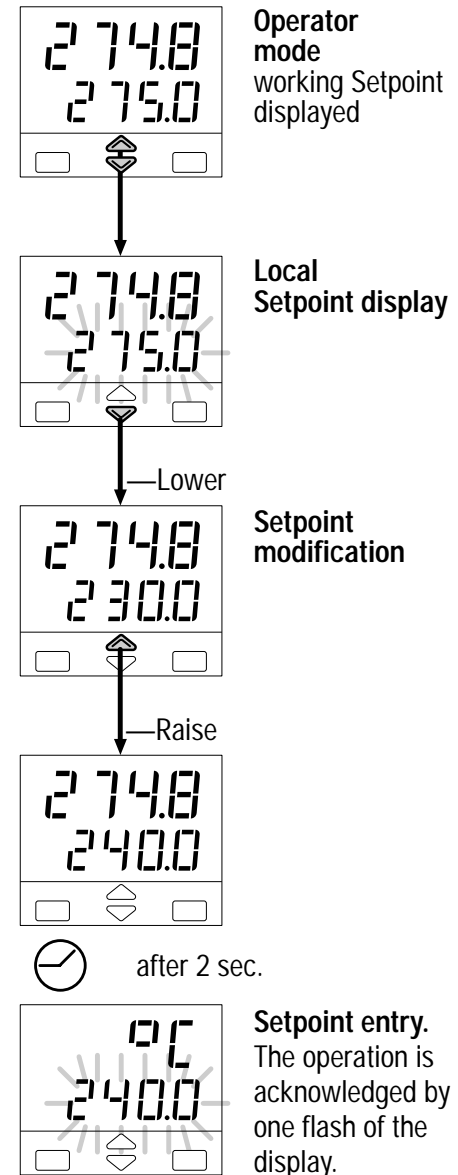

To evidence this change the display flashes once. Then the Setpoint can be modified



4.3.2 MNEMONIC CODES SETTING



(e.g. configuration see page 35)

Press the  or  to display the next or previous mnemonic for the selected parameter.

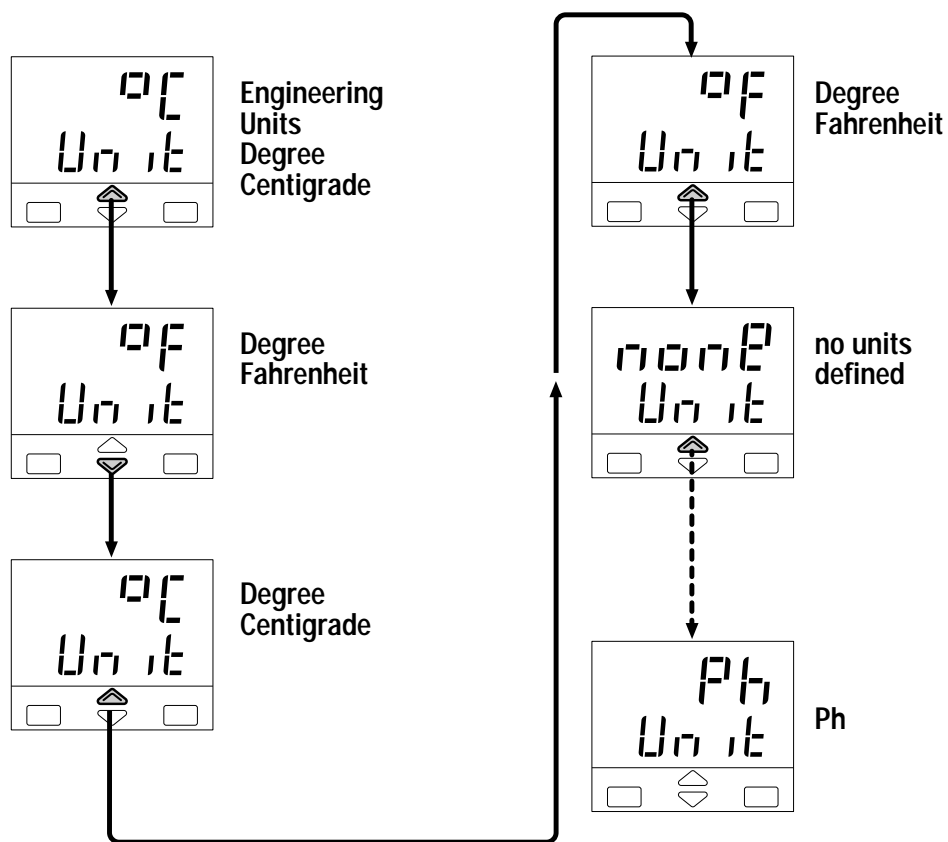
Continued pressing of  or  will display further mnemonics at a rate of one mnemonic every 0.5 sec. The mnemonic displayed at the time the next parameter is selected, is the one stored in the parameter.



4.3.3 KEYPAD LOCK

To lock/unlock the keypad press the keys  and  simultaneously for 2 seconds.

To confirm the keypad lock/unlock the display flashes once.

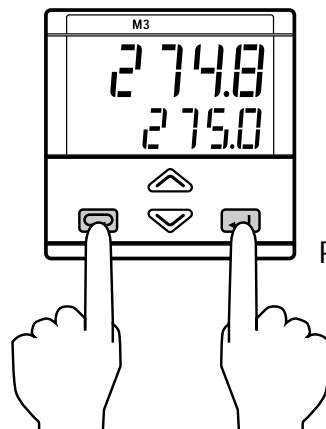



operator mode

Press simultaneously
for 2 seconds

The keypad lock/unlock can be achieved by serial communications too.

 The keypad lock is maintained in case of power failure.

4.3.4 OUTPUTS LOCK

The outputs are switched to the OFF status by pressing the keys  and  together.

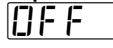
When the outputs are locked, the message  is displayed instead of the Setpoint value.

To unlock the outputs press again the keys simultaneously (the Soft-start will be enabled).

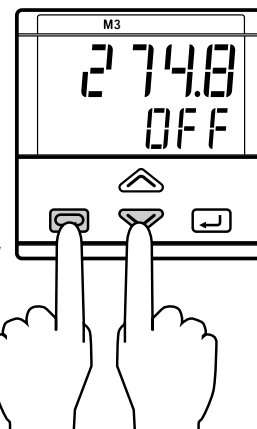

The outputs lock/unlock can be achieved by serial communications too.

 The outputs lock/unlock is maintained in case of power failure.

4.4 PARAMETERISATION

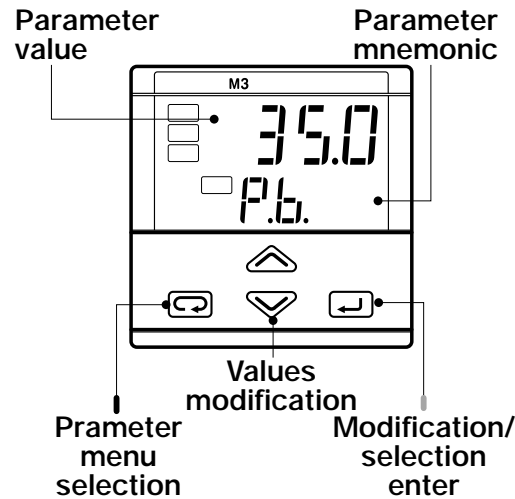

The parameter setting procedure has a timeout. If no keys are pressed for, at least, 30 seconds, the controller switches back, automatically, to the operator mode.

After having selected the parameter or the code, press and to display or modify the value (see page 22) The value is entered when the next parameter is selected, by pressing the key.

Pressing the key, the next group of parameters is presented on the display.

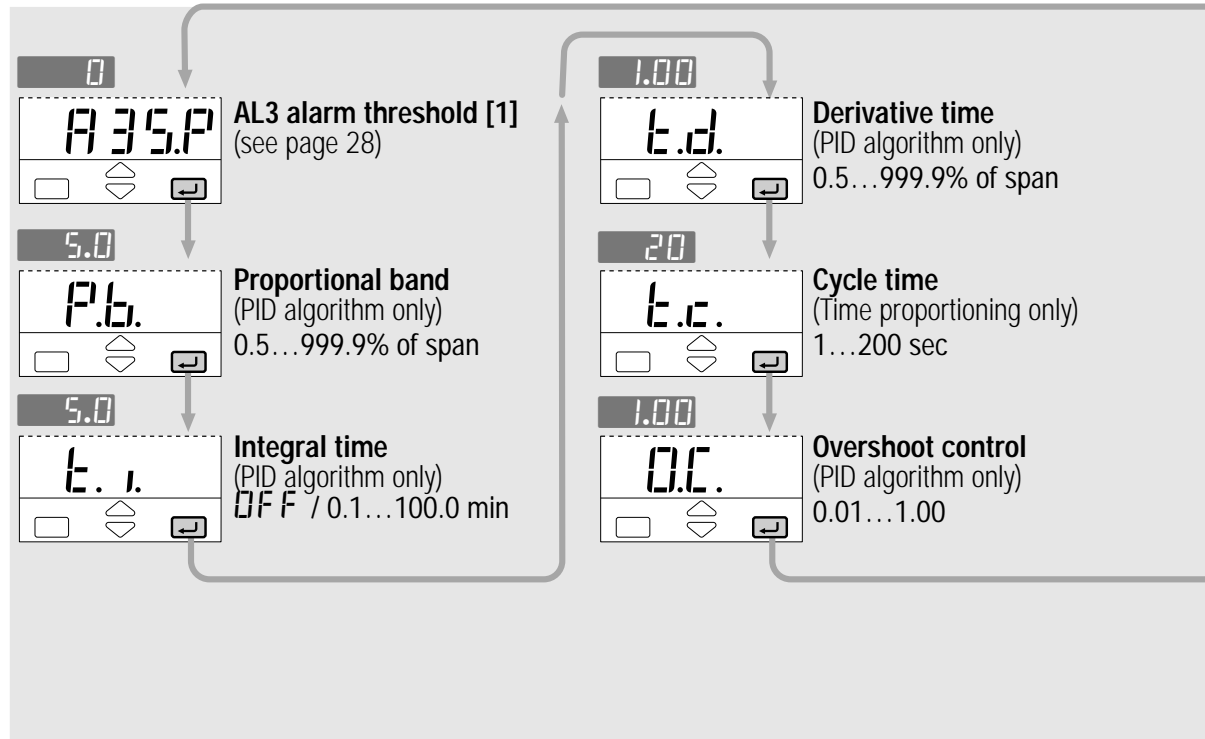
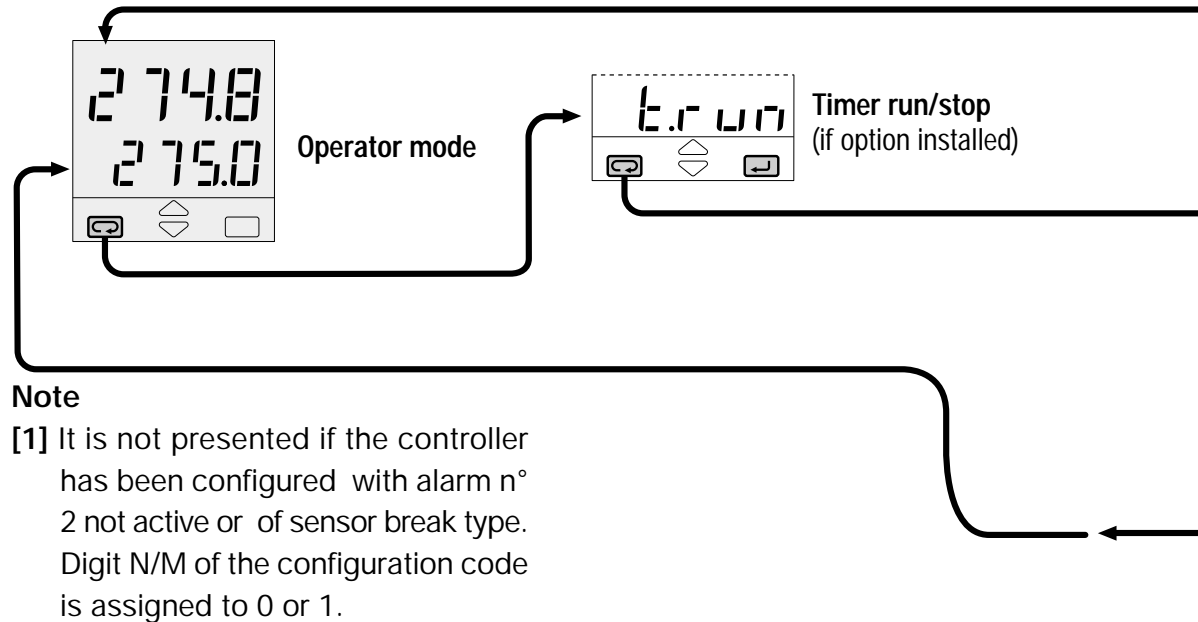

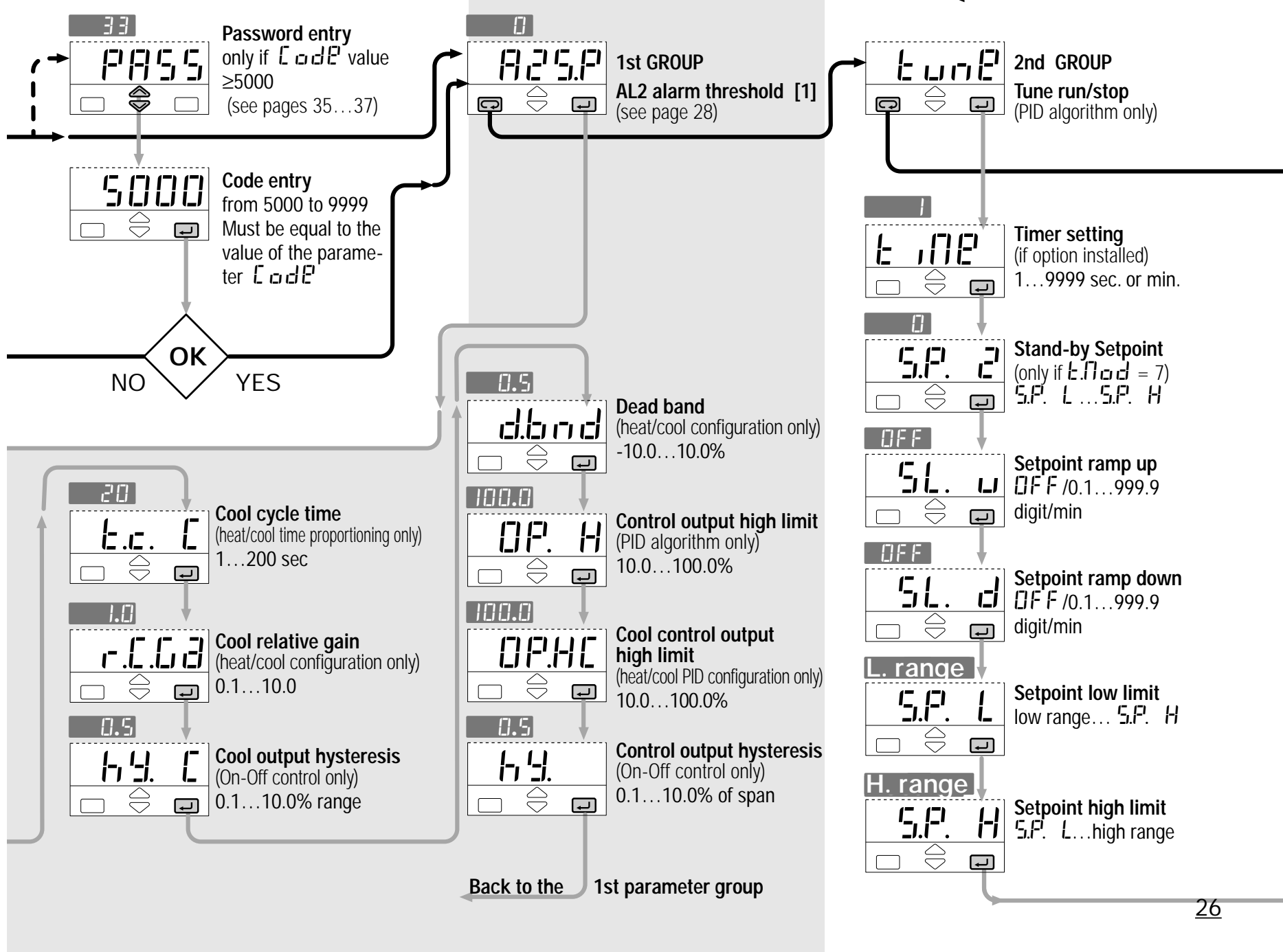

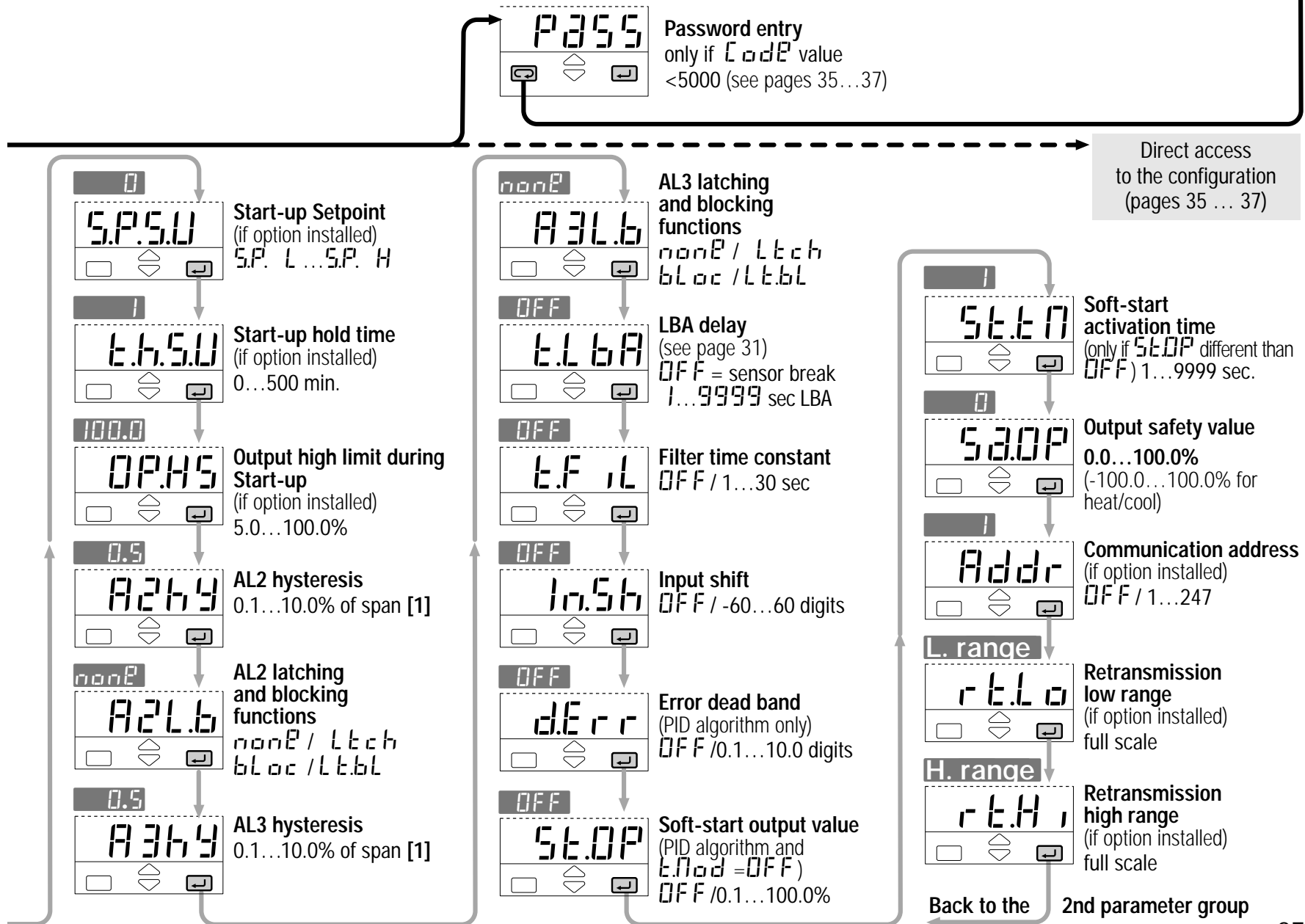



4.5 PARAMETERS

FIRST GROUP

The controller parameters have been organised in group, according to their functionality area.

-  AL2 alarm threshold
-  AL3 alarm threshold

The alarm occurrences handle the OP1, OP2 and OP3 outputs, in different ways, according to the configured types of alarms, as illustrated.

With double action control output, AL2 and AL3 share in or mode the same output (the free one) (see table on page 13)

Sensor break or input disconnection

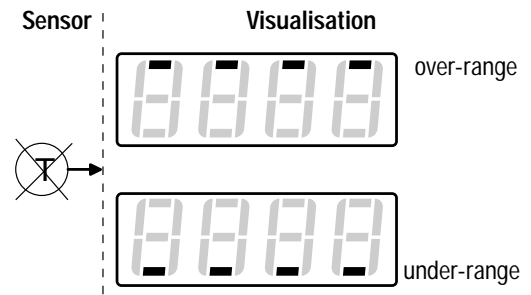

Absolute alarm (full scale)

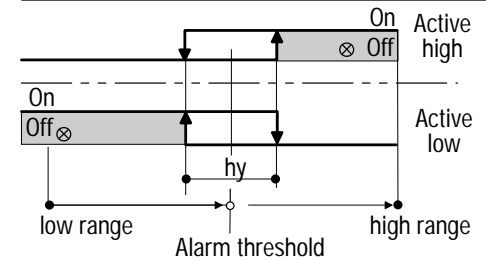

Deviation alarm

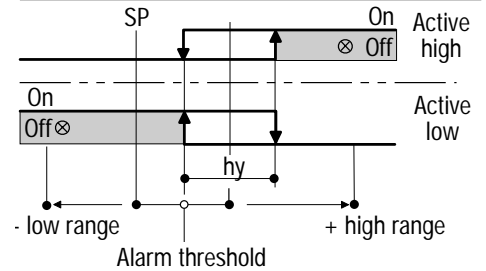

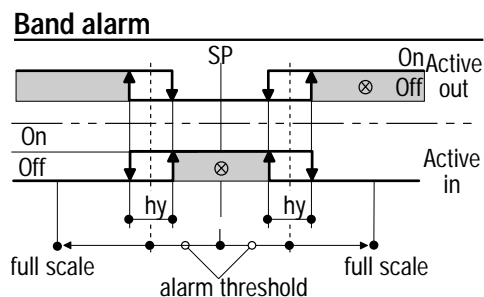

P.b. Proportional band

This parameter specifies the proportional band coefficient that multiplies the error (SP - PV)

I. t. Integral time

It is the integral time value, that specifies the time required by the integral term to generate an output equivalent to the proportional term. When *OFF* the integral term is not included in the control algorithm.

t.d. Derivative time

It is the time required by the proportional term P to repeat the output provided by the derivative term D. When *OFF* the derivative term is not included in the control algorithm.

t.c. Control output cycle time

t.c. Cycle time cool

It's the cycle time of the time proportioning control output. The PID control output is provided through the pulse width modulation of the digital waveform.

OC. Overshoot control

This parameter specifies the span of action of the overshoot control. Setting lower values (0.99 → 0.01) the overshoot generated by a Setpoint change is reduced. The overshoot control doesn't affect the effectiveness of the PID algorithm.

Setting 1, the overshoot control is disabled.

dbnd Heat/Cool dead band

This parameter specifies the width of the deadband between the Cool and the Heat channel.

OP.H Control output high limit

OP.HC Cool output high limit

It specifies the maximum value the control output can be set

hy. Control output hysteresis

hy. C Cool output hysteresis

Hysteresis of the threshold

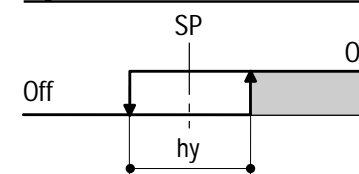

Control output hysteresis span, set in % of the full scale.

SECOND GROUP

5L.u

Setpoint
ramp up

5L.d

Setpoint
ramp down

This parameter specifies the maximum rate of change of the Setpoint in digit/min. When the parameter is OFF, this function is disabled.

5P.L

Setpoint
low limit

5P.H

Setpoint
high limit

Low / high limit of the Setpoint value.

A2h9

AL2
alarm hysteresis

A3h9

AL3
alarm hysteresis

Hysteresis of the threshold of both the alarms, that activate OP1 and OP2 control output. It is specified as a % of the full scale.

A2L.b

AL2, AL3
latching

A3L.b

and
blocking
functions

For each alarm it is possible to select the following functions

none none

Latching latching

blocking blocking

both latching and blocking both latching and blocking

Ltch

ALARM

ACKNOWLEDGE FUNCTION

The alarm, once occurred, is presented on the display until to the time of acknowledge.

The acknowledge operation consists in pressing any key.

After this operation, the alarm leaves the alarm state only when the alarm condition is no longer present.

blac

START-UP DISABLING

Ramp down

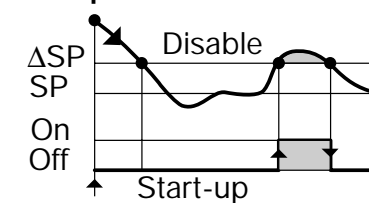

Ramp up

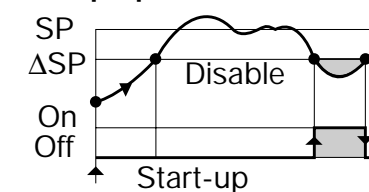

$\Delta SP \text{ Threshold} = SP \pm \text{range}$

ALARMS WITH LBA (LOOP BREAK ALARM) AND SENSOR BREAK OPERATION

Select the code 1 on **N** or **O** configuration indexes (see pages 18 or 19). The following parameter is then available:

E.L.B.A LBA delay

Setting a value between 1 and 9999 sec the alarm works as LBA+Sensor break with delay [1]. This condition is shown by means a red led as well as the blinking PV display.

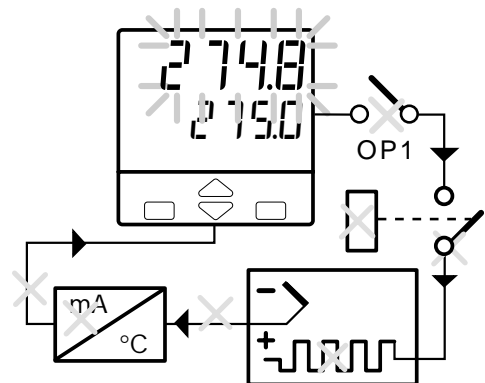

Setting OFF the alarm works as Sensor break with immediate action.

This condition is shown by means the red led of the selected alarm as well as:

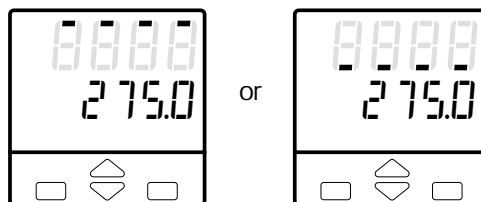

Note [1] In case of sensor break, condition, the alarm action is immediate.

When the cause of the alarm disappears, the alarm status stops.

E.F.tL Input filter time constant

Time constant, in seconds, of the RC input filter applied to the PV input. When this parameter is set to OFF the filter is bypassed.

Filter response

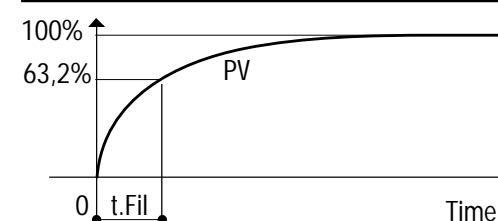

1n.5h Input shift

This value is added to the measured PV input value. Its effect is to shift the whole PV scale of up to ± 60 digits.

d.E.r.r Error Dead Band

Inside this band for $(PV - SP)$, the control output does not change to protect the actuator (output Stand-by)

SECOND GROUP

SE.OP Soft-start control output value

Value of the control output during the Soft-start activation time.

SE.EN Soft-start activation time

Time duration (starting from the power on) of the Soft-start function.

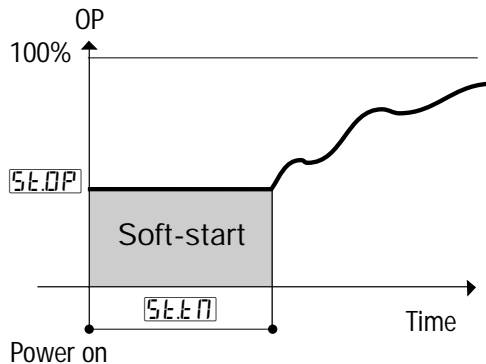

SA.OP Output Safety Value

Output Value in case of input anomaly

Addr Controller address

the address range is from 1 to 247 and must be unique for each controller on the communication bus to the supervisor.

When set to **OFF** the controller is not communicating

HEAT COOL CONTROL

By a sole PID control algorithm, the controller handles two different outputs, one of these performs the Heat action, the other one the Cool action.

It is possible to overlap the outputs.

The dead band parameter **dbnd** is the zone where it is possible to separate or overlap the Heat and Cool actions.

The Cool action can be adjusted using the relative cool gain parameter **r.c.gd**

To limit the Heat and Cool outputs the parameters **OP.H** and **OP.HC** can be used.

When there is an overlap, the displayed output **OUT** shows the algebraic sum of the Heat and Cool outputs.

RETRANSMISSION

A Heat /Cool actions separated

Insert positive `db.nd` value (0...10%)

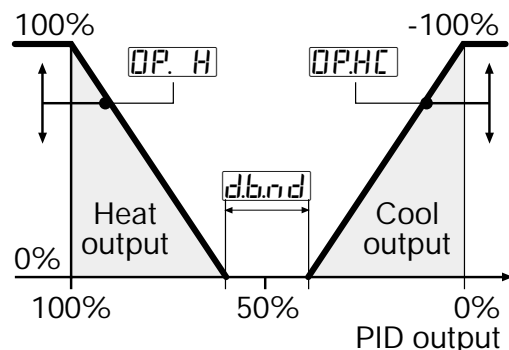

B Heat /Cool actions overlapped

Insert negative `db.nd` value (-10...0%)

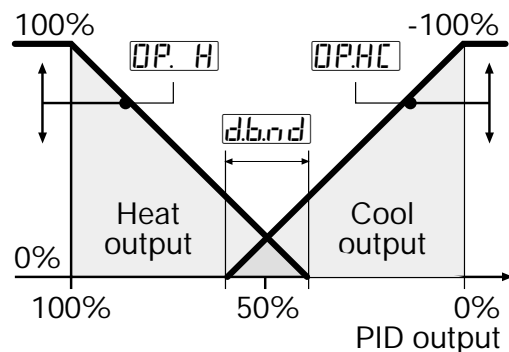

C Cool action adjusting

Example with different relative cool gains

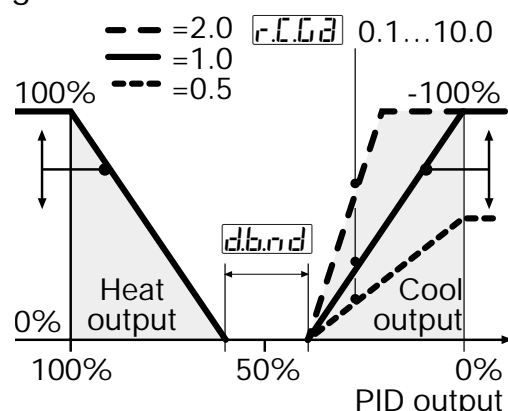

D On-Off Cool action

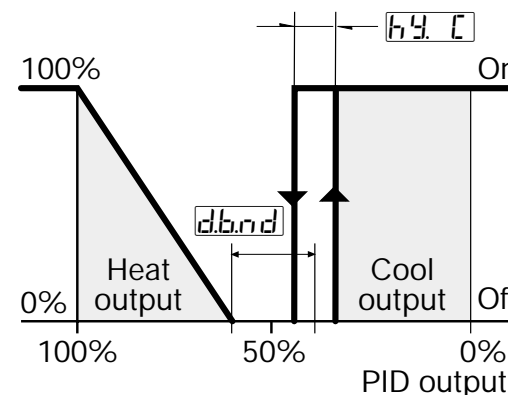

OP4 output, if present, retransmits linearised PV or the SP. On configuration (see page 37) it is possible to set:

`r.e.t.r` Output range 0-20 / 4-20
`r.e.H` Retrmitted signal P.U. /

S.P.
 The following parameters define the low and high range of the OP4 retransmission output corresponding to 0...4mA or 20mA (see page 27):

`r.e.l.o` Retrmission low range
`r.e.H` Retrmission high range

CURRENT TRANSFORMER INPUT

Example:

- T/C S, range 0...1600°C
- Output range, 4...20 mA
- Retrasmited signal PV on 800...1200°C range

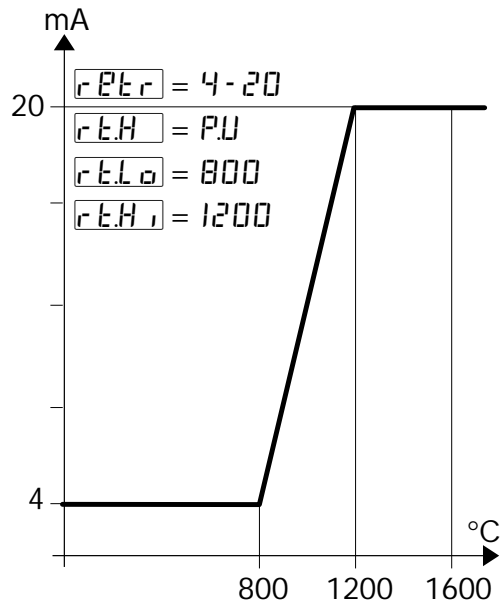

With rLQ greater than $rLH1$, it is possible to obtain a reverse scale.

With CT option it is possible to display the load current and set an alarm threshold.

It is possible to set AL2 or AL3 (index 8 and 9) to have an alarm when, during the ON time of the time proportional output, the load current is less then the specified threshold or, during the OFF time, there is at least 3% of full scale

load current

The alarm condition must be longer than 120 ms to set the alarm.

During the OFF time the parameter $tLur$ latches the last on time current value

Example:

CT input on OP1, alarm on AL2 during on time (configuration digit N = 8)

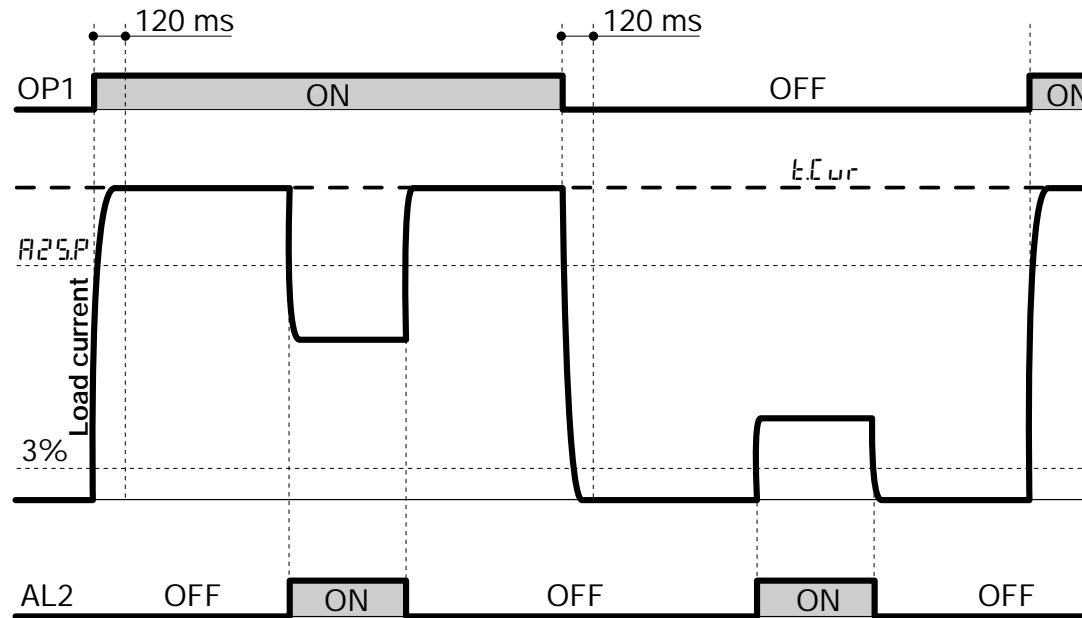

4.6 CONFIGURATION

The configuration of the controller is specified through a 4 digit code that defines the type of input, of control output and of the alarms. (sect. 3.2 page 18)

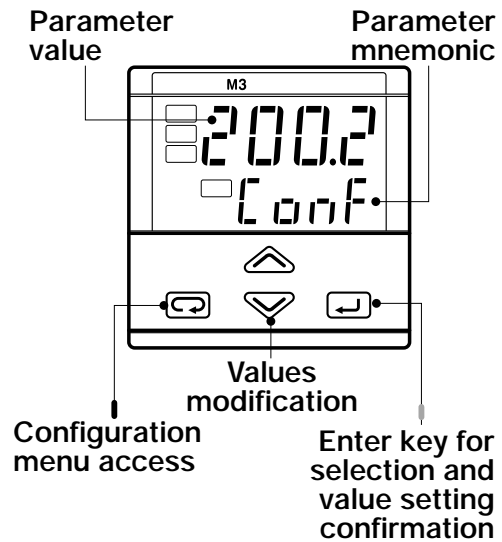

Press or to display the next parameter or the next code and change its value. The new value entered is stored into the controller when the next parameter is selected by pressing . Pressing the the next group of parameters is displayed.

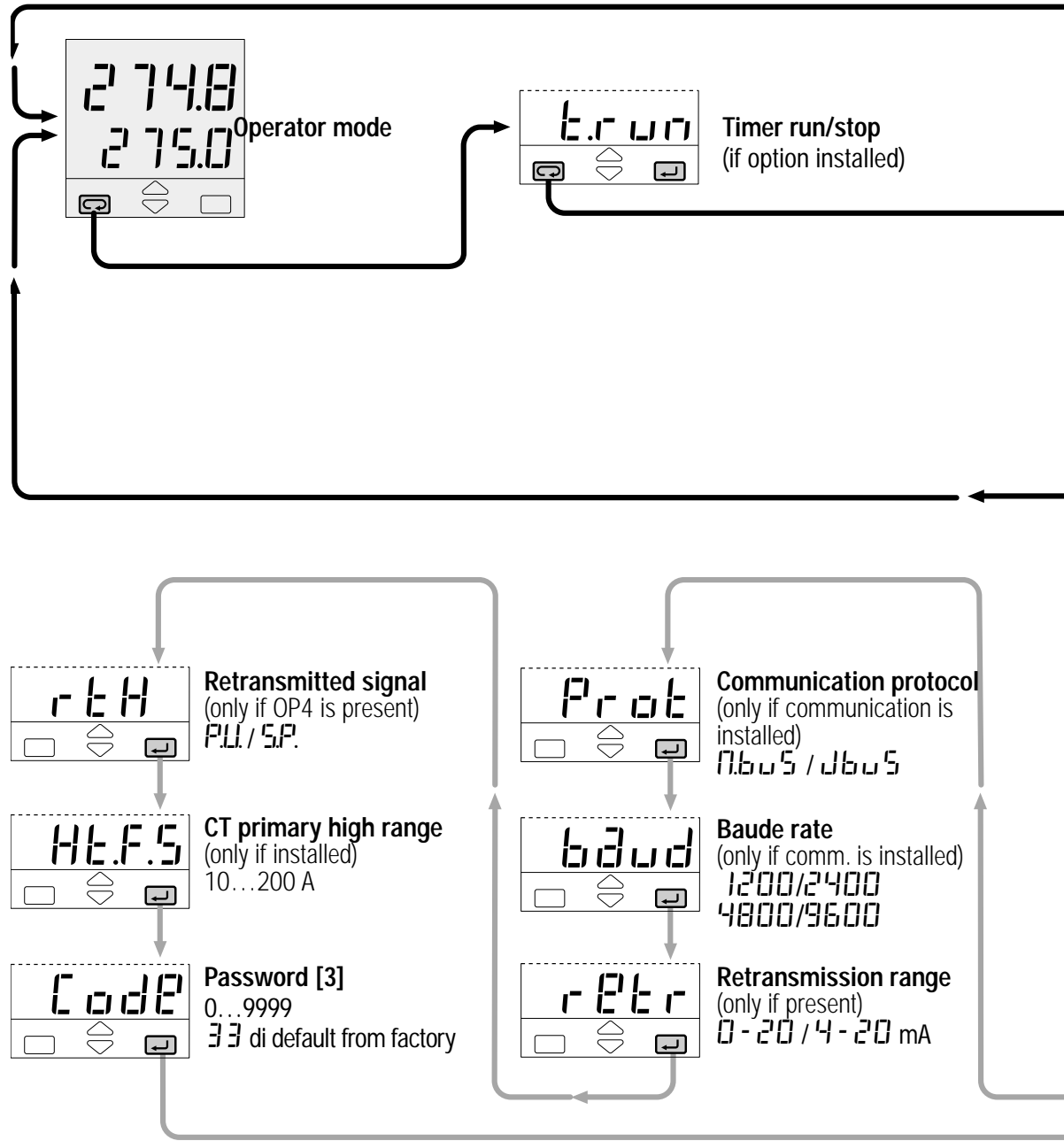

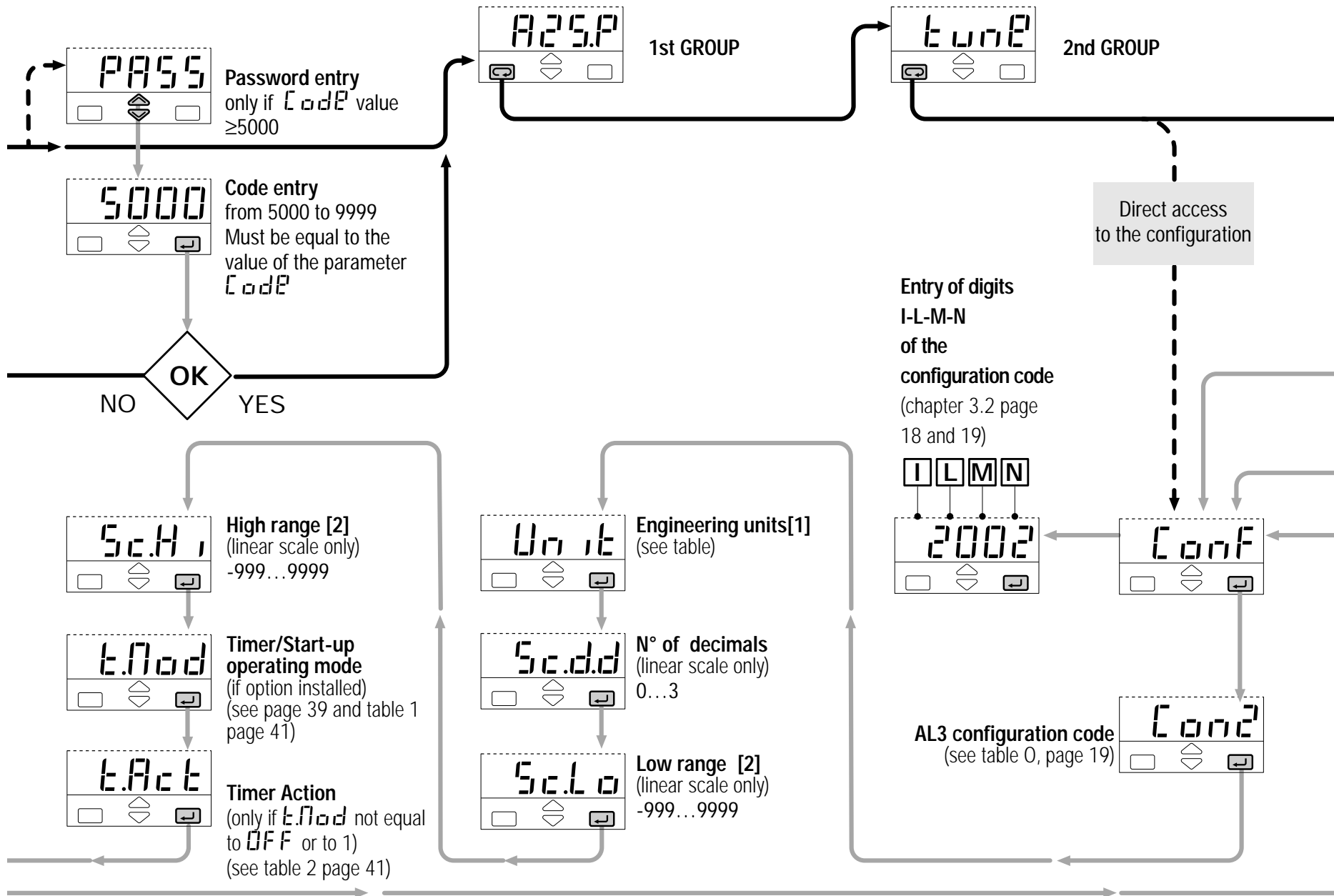

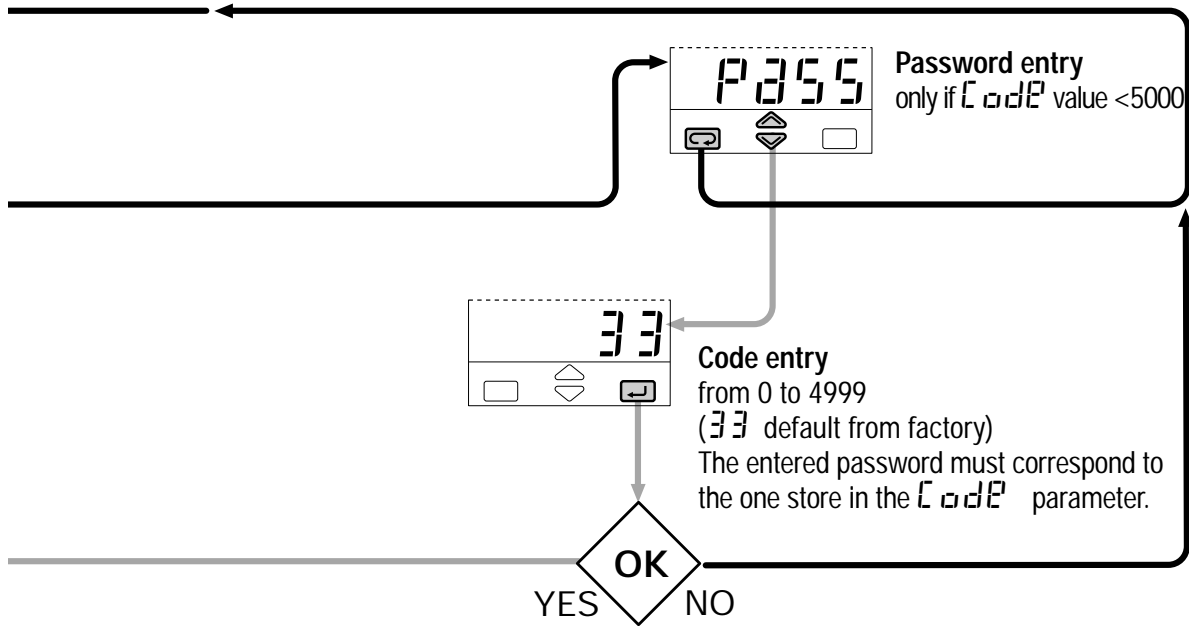

⚠
Direct access to the configuration

A From parameterisation (see page 27).

B At the first power on when the controller is not configured:

In this situation, the controller has its outputs and inputs not active.
This situation ends when a correct configuration code is entered.

Note

[1] Table of the supported Engineering Units.

Centigrade degrees*	°C
Fahrenheit degrees *	°F
none	none
mV	mV
Volt	V
mA	mA
Ampere	A
Bar	bar
PSI	PSI
Rh	rh
pH	pH

* For inputs from thermocouple or resistance thermometer, the choice is between °C and °F only.

[2] Minimum Range 100 digits.

[3] To avoid free parameter access insert 5000...9999

5 ■ AUTOMATIC TUNE

Start/stop of the Fuzzy Tuning
The Tuning operation can be started or stopped any time.

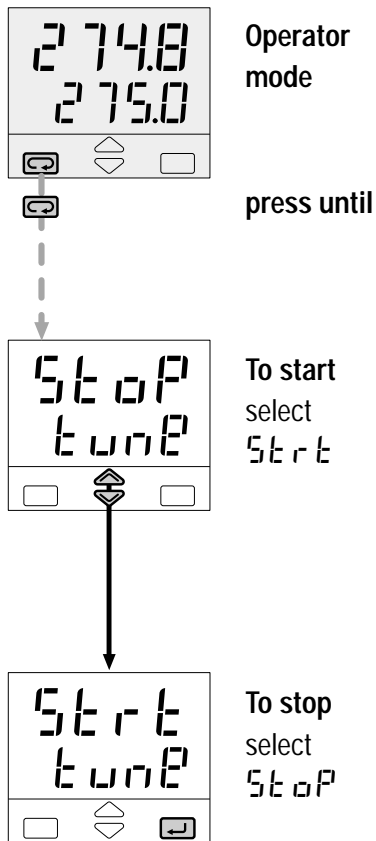

The green led **MAN** blinking goes on when the Fuzzy Tuning is in progress. At the end of this operation, the calculated PID terms parameter are stored and used by the control algorithm and the controller goes back to the operator mode. The green led **MAN** becomes off.

This function allows the calculation of the optimal PID terms parameters, monitoring the response of the process to disturbances. The controller provides 2 types of "one shot" tuning algorithm, that are selected automatically according to the process condition when the operation is started.

Step response

This type is selected when, at the start of the autotune operation, the PV is far from the Setpoint of more than 5% of the span. This method has the big advantage of fast calculation, with a reasonable accuracy in the term calculation.

Natural frequency

This type is selected when the PV is close to the SP Setpoint.

This method has the advantage of a better accuracy in the term calculation with a reasonable speed calculation.

The Fuzzy Tuning determines automatically the best method to use to calculate the PID term, according the process conditions.

Step response

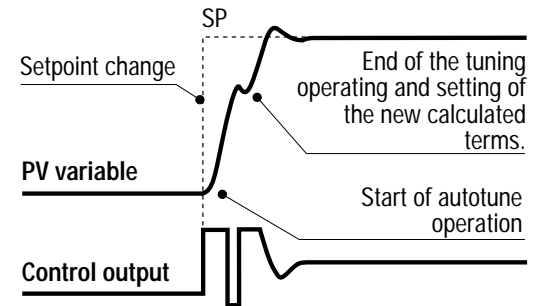

Natural frequency

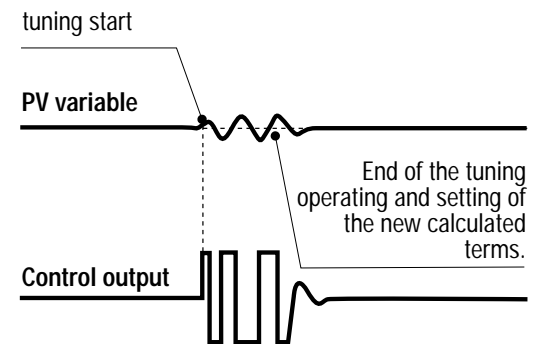

6 SPECIAL FUNCTIONS

Two special functions are available:

6.1 Start-up

6.2 Timer

In order to have the above functions the product code digit **E** must be **2** (see page 17)

For example: M3 3100-2000

To select these functions use the parameter:

E.NoD **Timer/Start-up operator mode**
(see page 35).

⚠ Selecting Timer or Start-up, the Soft-start function is disabled, therefore the parameters **SEOP and **SEEN** will not be shown.** (see page 27)

6.1 START-UP FUNCTION

continued on page 40

By means of this function it is possible to manipulate the control output when the controller is switched on.

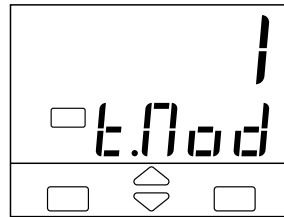

To configure Start-up function the parameter "Timer/Start-up operating mode" must be set to

Three parameters are associated to the Start-up function, they appear on the second group. (see page 27)

SP.SU **Start-up Setpoint**
(SP. L ... SP. H)

E.H.SU **Start-up hold time**
(0...500 min.)

OP.HS **Output high limit**
(5.0%...100.0% min)

The Start-up function includes three phases:

1st "Limy" - The control output is limited to the **OP.HS**

2nd "Hold" - The process variable is maintained to the Start-up Setpoint for the time fixed by the parameter **E.H.SU**

3rd "Off" - When the **E.H.SU** time is elapsed the process variable is maintained to the working Setpoint.

Whether the process variable, for any reason (e.g. load change), decreases at a value lower than (**SP.SU** - 40 digits), the Start-up function starts again from the "Limy" phase.

When the Start-up is in Hold phase, if the local Setpoint becomes lower than the Start-up Setpoint, the Start-up function passes to the "Off" phase.

continued **6.1 START-UP FUNCTION**

There are two possibilities:

A Start-up Setpoint SP_{SU} lower than the local Setpoint.

The "Hold" phase starts when the process variable PV achieves the SP_{SU} (with a tolerance of 1 digit).

B Start-up Setpoint SP_{SU} greater than or equal to the local Setpoint.

When the process variable PV achieves the local Setpoint (with a tolerance of 1 digit), the Start-up function passes directly to the "Off" phase.

If, at the controller power-on, the process variable PV is greater than the lowest between the SP_{SU} and the working Setpoint, the next phase ("Hold" or "Off") will be executed instead of the "Limy" phase.

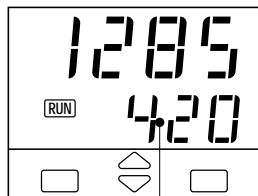

Start-up Setpoint

During the "Limy" and "Hold" phases the **RUN** led is on.

A $SP_{SU} < \text{local Setpoint SP}$

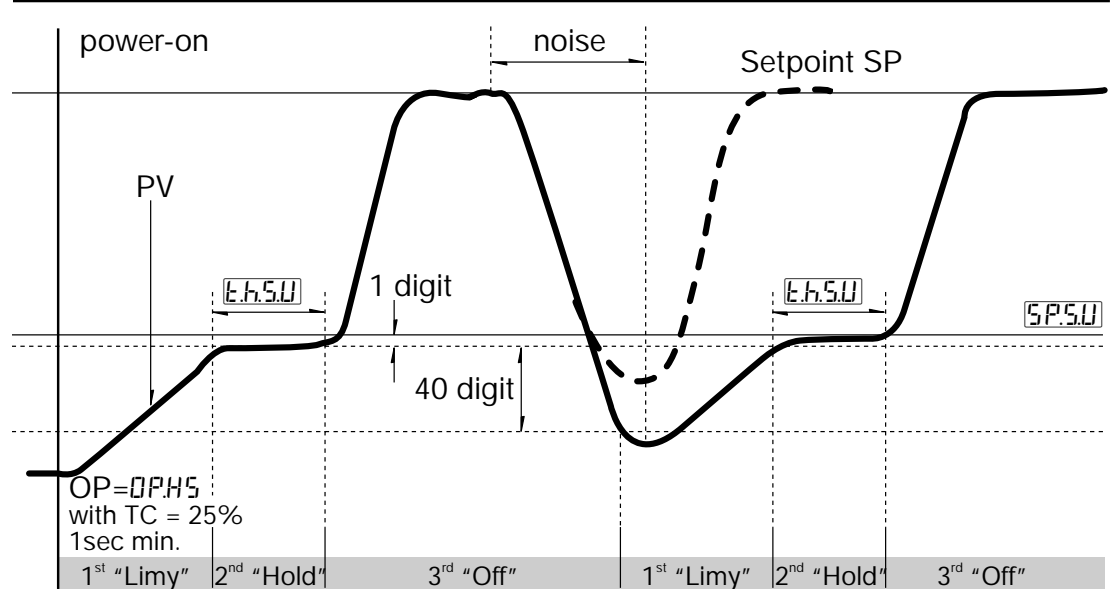

B $SP_{SU} \geq \text{local Setpoint SP}$

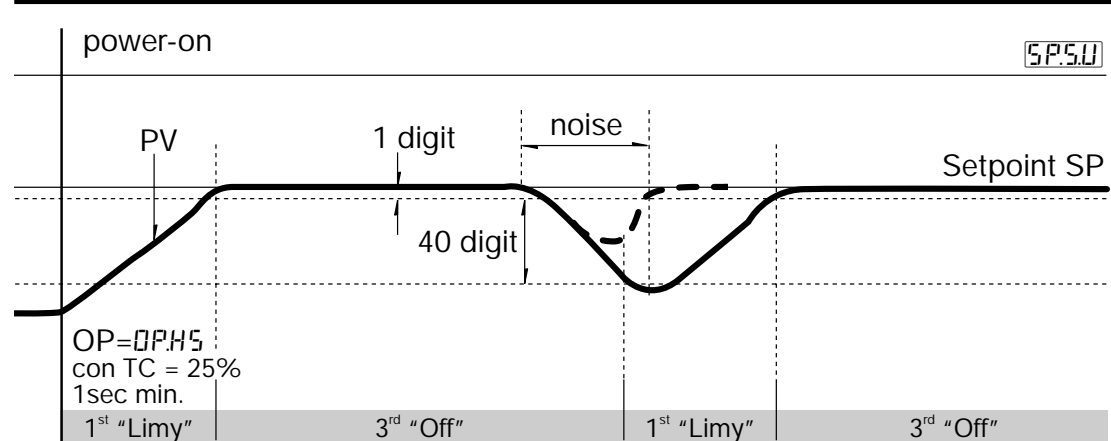

6.2 TIMER FUNCTION

To use AL3 in addition to this function, set the parameter **AL3** (AL3 configuration code) to **0**.

⚠ The Timer can't be enabled with Heat/Cool control.

The two following parameters (see page 37) must be set to select one of the six possible types of Timer.

t.Mode Timer/Start-up operating mode

By this parameter can be defined:

- the counting start time
- the control output status at the end of the counting

Table 1

Timer counting mode	Value
Counting start time	End mode
When inside the band	Control mode 2
	Output to 0 3
When launched	Control mode 4
	Output to 0 5
When launched. Control disabled	Control mode 6
When launched stand-by Setpoint	Control mode 7

t.Action Timer Action

By this parameter can be defined:

- the time units
- the starting mode
- the OP3 status when the timer is running.

When the timer is not running, the OP3 takes the opposite status.

Table 2

Time units	Starting mode	[1]OP3 status	Value
Seconds	Manual by keypad	Off	0
		On	1
	Auto at the power on [2]	Off	2
		On	3
Minutes	Manual by keypad	Off	4
		On	5
	Auto at the power on [2]	Off	6
		On	7

[1] If it is used by Timer.

[2] Using this selection, manual starting mode is possible too.

After the Timer configuration the following parameters will be shown on the second parameters group. (see page 26)

t.time Timer setting
(1...9999 sec/min.)

SP. 2 Stand-by Setpoint
(only for **t.Mode** = 7)
(**SP. L** ... **SP. H**)

6.2.1. DISPLAY

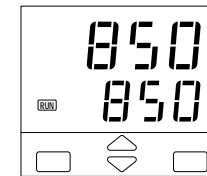

When the Timer is running, the led **RUN** is on.

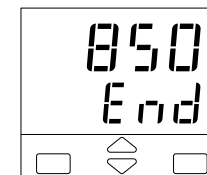

When the Timer ends, the Setpoint display shows alternatively the message **End** and the Setpoint

When the timer is running it is always possible to see the remaining time and to modify it.

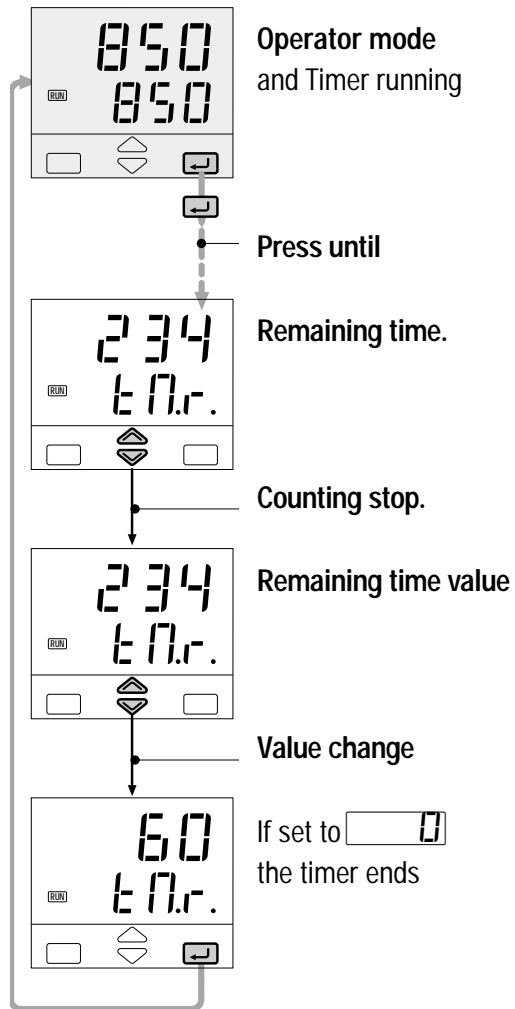

6.2.2 TIMER STARTING

Depending on the Timer action `[E.action]` selection, there can be two different starting ways:

- Automatic at the power on
- Manual by keypad or serial communications.

To start/stop the Timer:

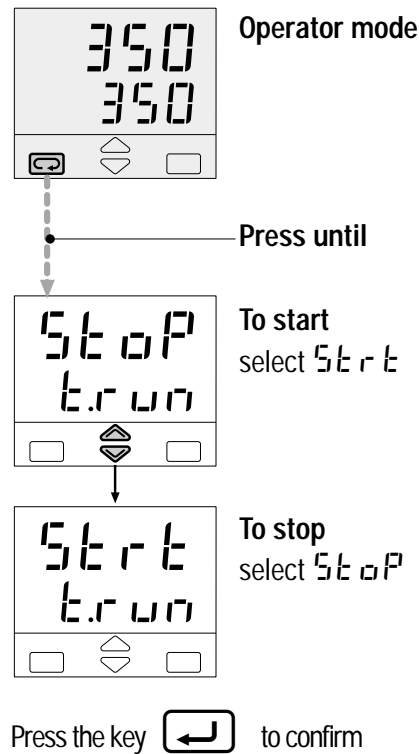

6.2.3 POWER FAILURE

If there is a power failure during the Timer execution, the value of the elapsed time is lost.

Depending on Timer action `[E.action]` selection, when the controller restarts you can have two different situations:

- with automatic mode (`[E.action] = 2, 3, 6, 7`), the Timer function starts again and the counting time is reinitialized.
- with manual mode (`[E.action] = 0, 1, 4, 5`), the control output is forced to `[0]` if `[E.mode] = 3 e 5`; otherwise the control action restarts using the working Setpoint

6.2.4 TIMER COUNTING MODES

A Counting start time inside the band, end in control mode.

The time counting starts only when the error is inside a ± 1 digit band. The control action is not affected by the Timer function.

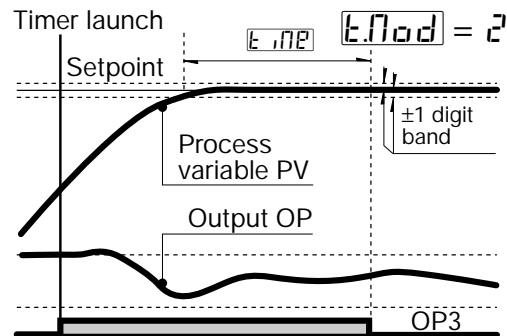

B Counting start time inside the band, end with control output forced to zero.

The time counting starts only when the error is inside a ± 1 digit band. At the end, the control output is forced to zero. [1]

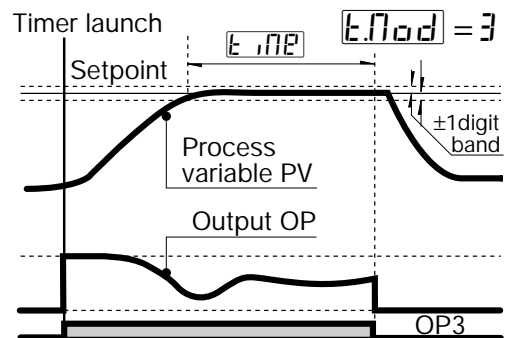

C Counting start time = timer launch time, end in control mode.

The time counting starts when the timer is launched. The control action is not affected by the Timer function.

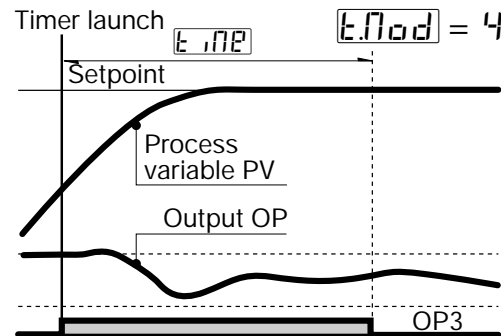

D Counting start time = timer launch time, end with control output forced to zero.

The time counting starts when the timer is launched. At the end, the control output is forced to zero. [1]

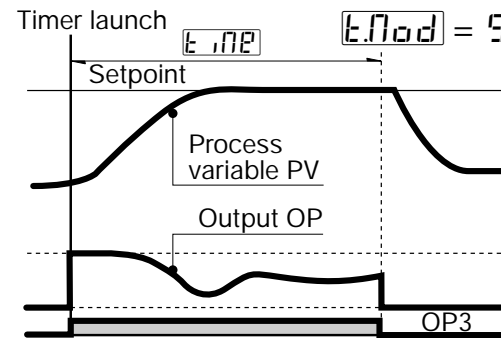

E No control action during the counting time.

The time counting starts when the timer is launched and the control output is forced to zero. At the end, the control action starts.

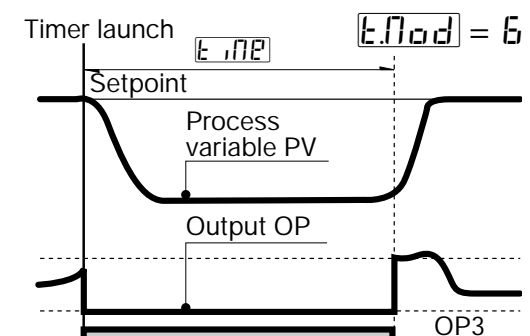

F Control action with stand-by Setpoint during the counting time

The time counting starts when the timer is launched and the control action use the Stand-by Setpoint. At the end, the control action use the working Setpoint.

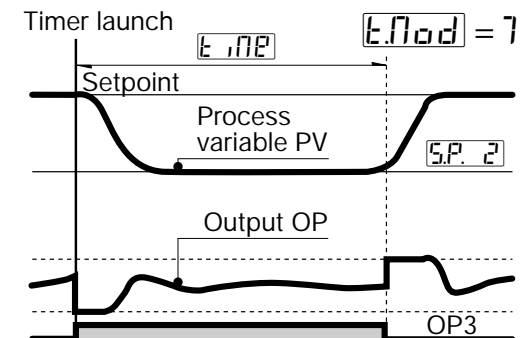

[1] When the Timer is not running the control output is forced to zero, also before the Timer launch

7 TECHNICAL SPECIFICATIONS

Features (at 25°C environmental temp.)	Description			
Total configurability (see par. 3.2 page 18 par. 4.6 page 35)	From keypad or serial communication the user selects: <ul style="list-style-type: none"> - the type of input - the type of control algorithm - the type and functionality of the alarms - the associated functions and the corresponding outputs - the type of output and the safe conditions - the values of all the control parameters. 			
PV Input (see page 11, 12 and page 18)	Common characteristics	A/D converter with resolution of 50.000 points Update measurement time: 0.2 seconds Sampling time: 0.5 seconds Input bias: - 60... + 60 digit Input filter with enable/disable: 1...30 seconds		
	Accuracy	0.25% ± 1 digits for temperature sensors 0.1% ± 1 digits (for mV and mA)		
	Resistance thermometer (for ΔT: R1+R2 must be <320Ω)	Pt100Ω at 0°C (IEC 751) °C/°F selectable	2 or 3 wires connection Burnout (with any combination)	Max. wire Res: 20Ω max (3 wires) Sensitivity: 0.35°C/10° E. T. <0.35°C / 10Ω Wire Res.
	Thermocouple	L,J,T,K,S (IEC 584) Rj >10MΩ °C/°F selectable	Internal cold junction compensation con NTC Error 1°C/20°C ±0.5°C Burnout	Line: 150Ω max Input drift: <2μV/°C. Env. Temp <5μV / 10Ω Wire Res.
	DC input (current)	4...20mA, 0-20mA with external shunt 2.5Ω Rj >10MΩ	Engineering units Conf. decimal point position Init. Sc. -999...9999	Input drift: <0.1% / 20°C Env. Temp.
	DC input (voltage)	10...50mV, 0-50mV Rj >10MΩ	Full Sc. -999...9999 (min. range of 100 digits)	

Features (at 25°C environmental temp.)	Description						
CT auxiliary input (option)	Current transformer (see page 12)	50 or 100 mA input hardware selectable	Current visualisation 10 ... 200A With 1A resolution and Heater Break Alarm				
Operating mode and Outputs	1 double action PID loop or On/Off with 1 or 2 alarms	Single action	Control output		AL2 alarm	AL3 alarm	
			OP1-Relay /Triac	OP2-Relay or SSR drive		OP3-Relay/Triac	
		OP2 SSR drive	OP1-Relay /Triac		OP3-Relay/Triac		
		Double action Heat/cool	OP1-Relay /Triac	OP3-Relay /Triac	OP2-Relay or SSR drive		
			OP1-Relay /Triac	OP2 SSR drive			OP3-Relay/Triac
			OP2 SSR drive	OP3-Relay /Triac		OP1-Relay /Triac	
Control mode	Algorithm		PID with overshoot control or ON OFF				
	Proportional band (P)		0.5 ... 999.9%				
	Integral time (I)		0.1 ... 100.0 min	OFF = 0		PID algorithm	
	Derivative time (D)		0.01 ... 10.00 min				
	Error band		0.1 ... 10.0 digit				
	Cycle time		1 ... 200 sec				
	Dead band		-10.0 ... 10.0%				
	Cool relative gain		0.1 ... 10.0			Heat / cool control action	
	Cool cycle time		1 ... 200 sec				
	Overshoot control		0.01 ... 1.00			PID algorithm	
High limit		100.0 ... 10.0% (heat) -100.0 ... -10.0%(cool)					
Hysteresis		0.1 ... 10.0%			On-Off algorithm		
OP1 output	SPST Relay N.O., 2A/250V~ for resistive load Triac, 1A/250V~ for resistive load				Protection by varistor for 220V ~ and capacitor		
OP2 output	SSR drive not isolated: 5V-, ± 10%, 30mA max SPST Relay N.O., 2A/250V~ for resistive load		Jumper selectable (page 13)				
OP3 output	SPST Relay N.O., 2A/250V~ for resistive load Triac, 1A/250V~ for resistive load						

7 - Technical specification

Features (at 25°C environmental temp.)	Description			
AL2 - AL3 alarms	Hysteresis 0.1...10.0% c.s.			
	Action	Active high	Action type	Deviation threshold ±range
		Active low		Band threshold 0...range
		Special function		Absolute threshold whole range
Sensor break, heater break alarm, Latching/Blocking, Loop Break Alarm				
Setpoint	Ramp up and down. User inhibited		0.1...999.9 digit/min	
	Low limit		from low range to high limit	
	High limit		from low limit to high range	
OP4 PV or SP retransmission (option)	Galvanic isolation: 500 V~/1 min Resolution 12bit (0.025%) Accuracy: 0.1 %		In current: 0/4...20mA 750Ω/15V max	
One shot Fuzzy-Tuning with automatic selection	The controller selects automatically the best method according to the process conditions		Step response	
			Natural frequency	
Serial comm. (option)	RS485 isolated, Modbus/Jbus protocol, 1200, 2400, 4800, 9600 bit/sec, two wires			
Auxiliary Supply	+18V- ±20%, 30mA max for external transmitter supply			
Operational safety	Measure input	Detection of out of range, short circuit or sensor break with automatic activation of the safety strategies and alerts on display		
	Control output	Safety value: -100%...100%		
	Parameters	Parameter and configuration data are stored in a non volatile memory for an unlimited time		
	Access protection	Password to access the configuration and parameters data, keypad lock, output lock		
General characteristics	Power supply (fuse protected)	100 - 240V~ (- 15% + 10%) 50/60 Hz or 24V~ (- 25% + 12%), 50/60 Hz and 24V- (-15% + 25%) Power consumption 2.6W max		
	Safety	Compliance to EN61010-1 (IEC 1010 – 1), installation class 2 (2500V) pollution class 2, instrument class II		

Features (at 25°C environmental temp.)	Description	
General characteristics	Electromagnetic compatibility	Compliance to the CE standards (see page 2)
	Protection EN60529 (IEC 529)	IP65 front panel
	UL and cUL Omologation	File 176452
	Dimensions	1/16 DIN - 48 x 48, depth 120 mm, weight 130 gr. apx.

■ WARRANTY

We warrant that the products will be free from defects in material and workmanship for 3 years from the date of delivery.

The warranty above shall not apply for any failure caused by the use of the product not in line with the instructions reported on this manual.

ASCON'S WORLDWIDE SALES NETWORK

SUBSIDIARY

FRANCE

ASCON FRANCE

Phone 0033 1 64 30 62 62

Fax 0033 1 64 30 84 98

AGENCE SUD-EST

Phone 0033 4 74 27 82 81

Fax 0033 4 74 27 81 71

AGENCE RÉGION-EST

Phone 0033 3 89 76 99 89

Fax 0033 3 89 76 87 03

DISTRIBUTORS

ARGENTINA

MEDITECNA S.R.L.

Phone +5411 4585 7005

Fax +5411 4585 3437

AUSTRALIA

IPA INDUSTRIAL PYROMETER

(AUST) PTY.LTD

Phone +61 8 8352 3688

Fax +61 8 8352 2873

FINLAND & ESTONIA

TIM-TOOL OY

Phone +358 50 501 2000

Fax +358 9 50 55 144

GERMANY

MESA INDUSTRIE ELEKTRONIK GMBH

Phone +49 2365 915 220

Fax +49 2365 915 225

GREECE

CONTROL SYSTEM

Phone +30 23 10 521 055-6

Fax +30 23 10 515 495

BRANCH OFFICE

Phone +30 1 646 6276

Fax +30 1 646 6862

HOLLAND

TEMPCONTROL I.E.P. B.V.

Phone +31 70 347 64 31

Fax +31 70 38 22 55 16

PORTUGAL

REGIQUIPAMENTOS LDA

Phone +351 21 989 0738

Fax +351 21 989 0739

SPAIN

INTERBIL S.L.

Phone +34 94 453 50 78

Fax +34 94 453 51 45

BRANCH OFFICES

Phone +34 93 311 98 11

Fax +34 93 311 93 65

Phone +34 91 656 04 71

Fax +34 91 656 04 71

SWITZERLAND

CONTROLTHERM GMBH

Phone +41 1 954 37 77

Fax +41 1 954 37 78

TURKEY

KONTROL SISTEMLERI LTD

Phone +90 216 527 96 15

Fax +90 216 527 96 20

UNITED KINGDOM

EUKERO CONTROLS LTD

Phone +44 20 8568 4664

Fax +44 20 8568 4115