

plug-in electronic digital thermostat for heating or cooling applications



Installation manual

**LEGGI E CONSERVA
QUESTE ISTRUZIONI**

**READ AND SAVE
THESE INSTRUCTIONS**

CAREL
Technology & Evolution



We wish to save you time and money!

We can assure you that the thorough reading of this manual will guarantee correct installation and safe use of the product described.

IMPORTANT WARNINGS



BEFORE INSTALLING OR OPERATING ON THE APPLIANCE, CAREFULLY READ THE INSTRUCTIONS IN THIS MANUAL.

This equipment has been designed to operate without risks for the specific purpose only if:

- the installation, operation and maintenance are performed according to the instructions in this manual;
- the environmental conditions and supply voltage fall within the values indicated here below;

Any other use or changes which have not been previously authorised by the manufacturer, are considered improper.

Liability for injuries or damage caused by improper use lies exclusively with the user. Note that voltage is present in some electrical components of this instrument, thus all the service or maintenance operations must be performed by expert and skilled personnel only, aware of the necessary precautions to be taken. Before accessing the internal parts, disconnect the power supply.

Disposal of the parts of the controller:

The controller is made up of metal and plastic parts. All these components must be disposed of according to the local legislation in force.



The CE mark confirms the quality and the safety of the plug-in series, guaranteed by the CAREL ISO 9001 certified design and production system.



INFORMATION FOR USERS ON THE CORRECT HANDLING OF WASTE ELECTRICAL AND ELECTRONIC EQUIPMENT (WEEE)

In reference to European Union directive 2002/96/EC issued on 27 January 2003 and the related national legislation, please note that:

1. WEEE cannot be disposed of as municipal waste and such waste must be collected and disposed of separately;
2. The public or private waste collection systems defined by local legislation must be used. In addition, the equipment can be returned to the distributor at the end of its working life when buying new equipment.
3. The equipment may contain hazardous substances: the improper use or incorrect disposal of such may have negative effects on human health and on the environment;
4. The symbol (crossed-out wheeled bin) shown on the product or on the packaging and on the instruction sheet indicates that the equipment has been introduced onto the market after 13 August 2005 and that it must be disposed of separately;
5. In the event of illegal disposal of electrical and electronic waste, the penalties are specified by local waste disposal legislation.

CONTENTS

INTRODUCTION	7
1. General characteristics	8
1.1 Models available	8
1.2 Characteristics	9
2. Hardware architecture	10
2.1 Meaning of the inputs and outputs	10
2.2 Instrument and accessory codes	10
2.3 User interface, meaning of operating indicators and LED display	12
3. Installation	13
3.1 Mechanical installation	13
3.2 Electrical connections	13
4. PARAMETERS - MODIFICATION	16
4.1 Modifying the set points and differentials	16
4.2 Accessing the parameters	17
4.3 Modifying the parameters	17
4.4 Saving the new values assigned to the parameters and exiting	17
4.5 Exiting the procedure without modifying the parameters	17
5. PARAMETERS – DESCRIPTION	18
5.1 Parameters - summary table	18
5.2 Classification of the parameters	19
5.3 The password PS	19
5.4 / = temperature probe management parameters	19
5.5 P = temperature differential parameters	20
5.6 r = regulation parameters	20
5.7 c = regulation timings management parameters	21
5.8 A = alarm management parameters	23
5.9 d = digital input parameters	24
5.10 H = other settings	25
6. Alarms and troubleshooting	26
6.1 Abnormal or special operation	26
6.2 Description of the main signals and alarms	26
6.3 Stored data error	27
6.4 Troubleshooting	28
7. Accessories supplied	29
7.1 Parameter copy key	29
8. Technical specifications	30
8.1 Characteristics of the relays used	31
8.2 Appendix: temperature/resistance correlation for NTC thermistors	31
9. Dimensions	32

INTRODUCTION

The new plug-in family for heating or cooling is made up of a new series of microprocessor electronic controllers with LED display, designed for the management of one or more control steps, from -50 °C to 150 °C.

A range of models is available, providing the best solution for all applications, at the most competitive price.

The plug-in family builds on the experience and success of the previous product ranges, such as the IR32 Universal, with the aim of offering an increasingly simple and economical product for temperature control requirements.

The main characteristics are:

- display in degrees (Centigrade or Fahrenheit), using display with two digits and a half and minus sign;
- complete range with models featuring 1, 2, 3 relays;
- ergonomic three-button keypad;
- possibility to manage two independent set points with two control probes and two relays (dual thermostat function).

Furthermore, new functions and characteristics have been introduced:

- probe inputs for NTC or PTC (depending on the models);
- display of operating status (active control outputs and second probe display), using a clearly visible and easily recognisable signal, thanks to the three buttons with back-lighting;
- highly-efficient red LED display;
- innovative fastening: from the front panel, using two screws in the TOP versions;
- front frames in various colours, customised upon request;
- quick programming, using hardware key, when the instrument is not powered (in the TOP versions);
- possibility to modify the list of parameters, selecting each parameter as a frequently-used or password-protected parameter;
- electrical connections using removable (screw or crimped) or fixed screw connectors;

1. General characteristics

1.1 Models available

The various models are differentiated according to the following functions and performance:

- operating mode and number of inputs and outputs for versions V, W, Z;
- complete versions (hereafter: **Top**) with serial connection, status LED, fastening from front panel, removable terminals;
- compact versions (hereafter: **Eco**) with fixed terminals and fastening only using rear bracket, and without serial connection;
- the power supply can be one of the following: 230 Vac, 115 Vac or 12 Vac/Vdc;
- the field of measurement: from -50 to +90 °C (-50 to 127 °F) with resistive NTC probe;
- the field of measurement: from -50 to +150 °C (-50 to 127 °F) with resistive PTC probe;
- digital input from free contact: in models where featured it is an alternative to the second probe;
- relay outputs: available with three different current ratings, 5 A, 8 A and 12 A (for resistive load);

PJ32V

This represents the ideal solution for the management of applications that require simple temperature control of the connected device (compressor, heaters, valves, etc) .

- All V models use one control probe only (S1) and feature a relay with changeover contacts for the control of the actuator.
- In some models (PJ32V00, PJ32V0P or PJ32V0H) the second probe can be connected to display the temperature (thermometer function); this probe has no influence on control.
- Models PJ32V0P and PJ32V6P use a relay with changeover contact, 12 A resistive. Model PJ32V0H uses a normally open relay, 16 A resistive, 2 HP. For all the other models, the normally open relay is 8A resistive.
- Both the **Top** and **Eco** versions are available, 230 Vac, 115 Vac e 12 Vac/Vdc.

PJ32W

These have been designed for the management of applications where a number of loads need to be controlled or the dual thermostat function is required.

- The W models feature two probe inputs for the temperature control function
- Two relay outputs are available for controlling the actuator; the relays used in models PJ32W00 and PJ32W10 are 8 A resistive, while in models PJ32W0H and PJ32W6H, OUT1 is associated with a 5A changeover relay, and OUT2 uses a normally open relay, 16 A resistive, 2 HP

PJ32Z

This represents the most complete solution. These models feature three relays, for complete control of up to two actuators and one alarm output. The 3 relays (8, 5 and 5 A resistive) can be fitted inside a compact container in the versions that feature the 230 Vac or 115 Vac power supply transformer, without affecting the performance or the reliability of the product.

- There are two probe inputs for the temperature control function.
- There are three outputs: relay output 1: 8 A resistive, output 2 and alarm output: 5 A resistive.

1.2 Characteristics

Power supply

The plug-in can be powered in accordance with the models at: 230 Vac or 115 Vac (using an internal transformer), or at 12 Vac/Vdc.

Aesthetics and ergonomics

The LED signals are clearly visible, thanks to the backlighting of the three buttons. The front panel frame can be customised both in terms of colour and indications.

LED display

The temperature and the parameter settings are displayed by **'two and a half digits'**. For the temperature values, the field of display is from $-50\text{ }^{\circ}\text{C}$ to $+150\text{ }^{\circ}\text{C}$ or from $-50\text{ }^{\circ}\text{F}$ to $+127\text{ }^{\circ}\text{F}$.

Alarm buzzer

The controls with one relay only can be fitted as standard with a buzzer for signalling alarms.

Multifunction input

The digital input, when present, can be used to change the set point or to manage serious alarms which require the immediate (e.g. high pressure) or delayed (e.g. low pressure) shutdown of the unit.

Connections

The economical versions (**Eco**) maintain the traditional fixed terminals, while the complete versions (**Top**) use removable terminals. The latter significantly simplify the installation and maintenance of the unit.

Relay outputs

There are, according to the model, up to three relays for the control of **two regulation outputs** and **alarm signal**. When more than one relay is fitted, the common of all the relays is connected and is available on just one terminal.

Multifunction output

The alarm relay output, when present, can be set using a parameter to be normally activated or normally deactivated. In the models with two relays, output 2 (**out2**) can be configured by parameter as a second regulation output or as alarm signal relay.

Keypad and parameter protection

The keypad can be disabled to avoid tampering by unauthorised persons.

Serial connection

The Top versions feature the connection of a parameter copy key that allows the parameters to be duplicated and configured.

Display of the second probe

In the models with two probes, only the measurement of the second probe can be displayed.

Fastening

The fastening method used for the economical models (**Eco**) uses a rear-panel fastening bracket, while all the other versions (**Top**) also feature the possibility of fastening **from the front panel**, using two screws.

Electromagnetic compatibility

The plug-in series conforms to EU standards on electromagnetic compatibility:

- for appliances for domestic use EN55014-2 and EN55014-1;
- for residential, commercial and light industrial environments EN50082-1 and EN50081-1;
- for industrial environments EN50082-2 and EN50082-1 ;
- regarding safety, it conforms to standards EN60730-1 and EN60730-2-9.

2. Hardware architecture

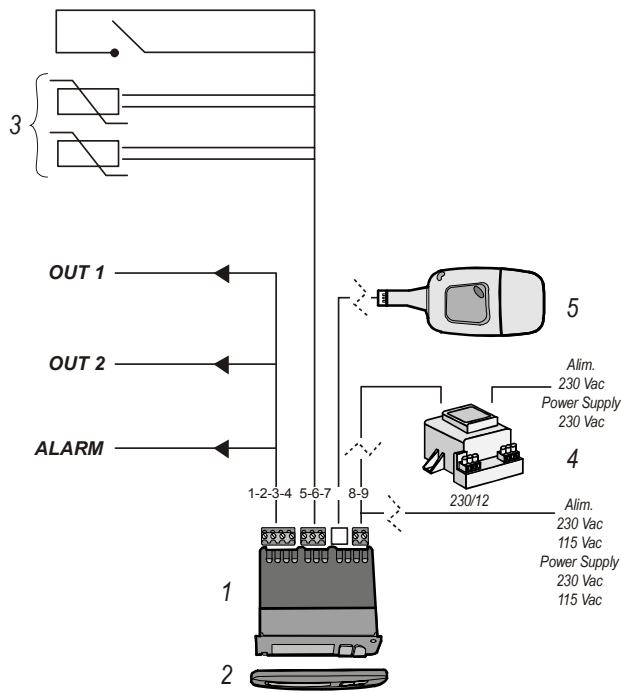

Fig. 2.1.1

The PJ32V/W/Z series instruments are temperature controllers that can be used for the control of refrigeration, air-conditioning and heating units.

An application diagram is shown in the figure; this also indicates the possible accessories and expansions, as well as the connections for the inputs and outputs:

1. instrument;
2. plug-in frame;
3. temperature probes;
4. power supply transformer (models 12 Vac);
5. parameter programming key (only for the TOP models).

This manual only describes the characteristics of the instrument, with a brief mention of the accessories and expansions.

2.1 Meaning of the inputs and outputs

	DESCRIPTION (numbering of the terminals refers to Fig. 2.1)
POWER SUPPLY	Terminals 8 and 9; the value of the power supply may be 230 Vac, 115 Vac or 12 Vac/Vdc. The effective value is indicated on the connection label.
TEMPERATURE PROBES	Terminals 5 and 6 are necessary for the connection of the temperature probe 1. Terminals 6 and 7 are necessary for the connection of the temperature probe 2, when featured.
DIGITAL INPUT	Terminals 6 and 7 are for the digital input from free contact, when featured
RELAY OUTPUTS	The group of terminals numbered 1, 2, 3, 4 are for the connection of the relay outputs. The assignment of the outputs can change according to the code, the effective assignment is indicated on the connection label. - For instrument codes with one relay only, the changeover contact is available for actuator control, using terminals 1, 2, 3. - For instrument codes with two relays, the changeover contact is available for "out2", on terminals 1, 2, 3, and the closing contact for the relay "out1" on terminals 3 and 4. Terminal 3 is common for the two relays, thus the current at the terminal will be the sum of the two. - For instrument codes with three relays, terminal 1 is used for "out1", terminal 3 for "out2", terminal 4 for "signalling" and terminal 2 is the common of all three relays. Note: The current at terminal two will be the sum of the three outputs.
COPY KEY CONNECTION	The four-pin connector is for connecting the parameter copy key. This connection is not present on the Eco models

Table. 2.1.1

2.2 Instrument and accessory codes

The definition of the instrument codes is based on two categories: one for the simpler and more economical versions (**Eco**), and one for the versions complete with all functions (**Top**). The **Top** versions have the following additional features:

- removable terminals in the place of fixed terminals;
- fastening from front panel using screws;
- serial connector present, with the possibility to connect expansion modules and to the key.

Warning: the options indicated **are not** all freely modular

The front panel frame is supplied in grey (standard for the single instrument), it can be customised in terms of colour and text, and can thus be ordered separately or in a kit.

2.2.1 Codes for the instruments in individual packaging

Eco models with 1 relay: fixed terminals	code
PJ32V 230 Vac – PTC probe -no options- screw terminals 8 A relay SPDT	PJ32V6E000
PJ32V 12 Vac – PTC probe -no options- screw terminals 8 A relay SPDT	PJ32V6EL00
Top models with 1 relay: removable terminals	code
PJ32V0P 230 Vac - 2 NTC probes - removable terminals-16 A SPDT relay - buzzer	PJ32V0P000
PJ32V6P 230 Vac - 2 PTC probes - removable terminals-16 A SPDT relay	PJ32V6P000
PJ32V0H 230 Vac - 2 NTC probes – plug-in terminals- relay 16 A resistive, 2HP	PJ32V6H00
Top models with 2 relays: plug-in terminals	code
PJ32W00 230 Vac – 2 NTC probes - 2 x 8 A relays	PJ32W00000
PJ32W10 230 Vac – 1 NTC probe - 2 x 8 A relays – 1 digital input	PJ32W10000
PJ32W0H 230 Vac – 2 NTC probes - relay OUT 1 (5 A) + relay OUT 2 (16 A resistive, 2HP)	PJ32W0H000
PJ32W6H 230 Vac – 2 PTC probes - relay OUT 1 (5 A) + relay OUT 2 (16 A resistive, 2HP)	PJ32W6H000
Top models with 3 relays: removable terminals	code
PJ32Z 230 Vac - 2 NTC probes - OUT1 relay (8 A) + OUT2 relay (5 A) + alarm relay (5 A)	PJ32Z00000
PJ32Z 230 Vac - 2 PTC probes - OUT1 relay (8 A) + OUT2 relay (5 A) + alarm relay (5 A)	PJ32Z60000

Detailed relays characteristics are given in chapter 8 (Technical specifications)

WARNING: the versions of instrument with display colours other than red are currently not available.

2.2.2 NTC and PTC probes

All PTC and NTC probes conforming to the CAREL standard can be used, with resistance values of 985 Ω at 25 °C, for PTC, and of 10 k Ω for NTC. Below are some codes of the more common versions.

description	operating range (°C)	index of protection	code
NTC probe, 6x15 mm bulb, plastic case	-50T50	IP67	NTC0**HP00
NTC probe, 6x40 mm bulb, metal case	-50T100	IP67	NTC0**W*00
NTC probe, wall-mounting	-10T70	IP30	ASWT011000
NTC probe, duct	-10T70	IP40	ASDT011000
PTC probe, 6x40 mm bulb, metal case, 1.5 m long	-50T100	IP67	PTC015W000

2.2.3 Accessories

Transformers (only for instruments with 12 Vac power supply).

TRA12: 3 VA, 240/12 Vac without fuse on the primary	TRA12VDE00
TRA12: 3 VA, 240/12 Vac with fuse on the primary	TRA12VDE01

Programming key

Programming key for plug-in	PJOPZKEY00
-----------------------------	------------

Plug-in frames in various colours

pack of 30 frames, GREY (STANDARD)	PJOPZFG000
pack of 30 frames, BLUE	PJOPZFB000
pack of 30 frames, RED	PJOPZFR000
pack of 30 frames, WHITE	PJOPZFW000
pack of 30 frames, YELLOW	PJOPZFY000
pack of 30 frames, ALUM. METAL	PJOPZFMA00
pack of 30 frames, BLUE METAL	PJOPZFMBO0
pack of 30 frames, GOLD METAL	PJOPZFMGO0
pack of 30 frames, STEEL METAL	PJOPZFMS00

Codes for kits: if requested by the customer and the quantity supplied is sufficient, the plug-in instruments can be packaged in multiples of 10. The kit also allows the instrument the ordered together with the options and accessories used by customer in the application. Customised programming of the parameters can also be requested.

The kit codes are defined according to customer request.

WARNINGS:

- the kits are packs of 10 instruments with the corresponding accessories; orders must indicate the total quantity of instruments required (not the number of packs); the quantity ordered must be a multiple of 10, as partial packs are not supplied;
- the quantity of each component in the kit is 10 units, except for the instruction sheet, which can be ordered in single quantities;
- the customized versions can be made only if compatible with the instrument internal bonds and against suitable quantities and kit requests.

2.3 User interface, meaning of operating indicators and LED display

Fig. 2.3.1 shows the front panel of the controller, on which there are three keys backlighted by as many LEDs (ref. ①②③) and the two and a half digits display and sign (ref. ④).

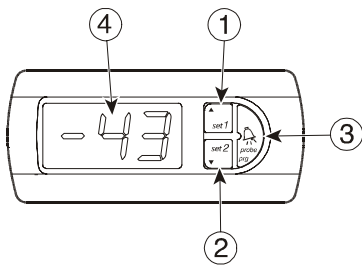

Fig. 2.3.1

LEDs meaning:

① this green LED indicates the status (ON or OFF) of the output associated with **set point 1**, as shown following:

on steady	regulator on
flashing	activation request pending

② this green LED indicates the status (ON or OFF) of the output associated with **set point 2**, as shown following:

on steady	regulator on
flashing	activation request pending

③ **Displayed probe signal:** yellow LED, present only in the models with two probes; it turns on to indicate that the displayed probe is **S2**.- If it is OFF, the displayed probe is **S1**.

④ **The display** shows one of the following information in accordance with function in progress:

- in normal operation: value measured by probe 1 or probe 2;
- when setting parameters: code of the parameter or the associated value;
- during an alarm event: flashing code of the alarm detected, alternating with the temperature value.





The temperature measured by the probe is displayed with resolution of 1 °C or 1 °F according to the parameter /5.

Association between the LEDs and the outputs:

1. models without digital input or with **dI** ≠ 2:
 - LED ① is always associated with **out 1**;
 - LED ② is always associated with **out 2**, but remains off if this is configured as an alarm signal;
2. models with digital input used to change the set point (**dI** = 2):
 - the LEDs turn on alternately when **out1** is activated respectively by **set point 1** or **set point 2**.

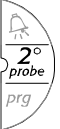
2.3.1 Using the keypad

Three buttons (5, 6 and 7 in Fig.2.3.1) are used to activate and deactivate of the instrument's operating modes and set the parameters. The use of the buttons can be divided into two different situations: one in normal operation, and the other when setting the parameters. For each button, the following are the possible actions associated with both possibilities.

-  If pressed for more than 1 second in **normal operation**:
- selects set point 1, displaying "°1".
- In parameter modification mode:
- passes from one parameter to the next;
 - increases the value of the parameter.
-  In **normal operation**:
- silences the audible alarm (only if featured);
 - if pressed for more than 5 s and no alarm is present: accesses the menu for setting the type 'F' parameters (frequent);
 - if pressed when switching the instrument on, together with the  button, activates the parameter RESET procedure.
- In **set point selection** mode:
- displays and/or sets the selected **set point**.
- In **parameter modification** mode:
- displays the value of the selected parameter/exits the display;
 - if pressed for more than 5 seconds in parameter modification mode, saves the changes.
-  If pressed for more than 1 second in **normal operation**:
- if the second set point is available, selects set point 2, displaying "°2", otherwise it selects set point 1, displaying "°1".
- In **set point selection** mode:
- switches between the modification of set point 1 and set point 2 (if available).
- In **parameter modification** mode:
- passes from one parameter to the next;
 - increases the value of the parameter.
-   **Alternate probe display.** In case there are two probes, pressing at the same time the keys UP and DOWN allows displaying the alternative probe.

3. Installation

The installation operations for the plug-in controls can be grouped as follows:

1. mechanical installation;
2. electrical connections: probes, power supply and actuators;
3. setting of the operating parameters (see chapter "*Parameters – Modification*").

3.1 Mechanical installation

1. Insert the instrument in the previously created hole as per the drilling template, 71x29 mm;
2. for mounting using the bracket (for all **Eco** versions): lock the instrument onto the panel, by sliding the bracket;
3. for mounting using screws from the front panel (only for the **Top** versions): rest the instrument on the front panel and, using the screwdriver tighten the two screws, making sure the two teeth are properly clicked in. The following describes the procedure in detail. The thickness of the fastening panel must not exceed 3 mm;
 - 3.1 remove the front panel frame and check that the two attachment teeth are in their slot (they must not protrude from the dimensions of the drilling template). If necessary, unscrew the two screws, applying pressure. Do not unscrew too much, the screw must not be raised from the front panel;
 - 3.2 connect all the cables to the corresponding terminals or insert the pre-wired removable terminals onto the corresponding connectors;
 - 3.3 insert the instrument in the hole in the panel, placing the connected cables inside, and hold it in position by pressing in the centre of the front panel; using the screwdriver, tighten the lower screw 90°, the tooth must come out of its slot and click onto the panel, then tighten up until the front panel is secure;
 - 3.4 repeat the same operation for the upper screw;
 - 3.5 if the tooth does not click onto the panel (max. thickness 3.0 mm), unscrew the screw, applying pressure at the same time with the screwdriver so that the tooth moves back. As mentioned in point 1, do not unscrew too much, the head of the screw must not be raised from the surface of the front panel;
 - 3.6 the two screws must be tightened with the same pressure, so as to not leave one corner higher than the other. **DO NOT** tighten excessively, **when the front panel is secure simply tighten a further ½ turn to compress the gasket**;
 - 3.7 apply the front panel frame.
4. If having to remove the instrument, proceed as follows:
 - 4.1 unclip the front panel frame;
 - 4.2 unscrew the lower screw, at the moment the front panel leaves the panel keep pressure on the screw and unscrew a further 90° to make the tooth go back into its slot;
 - 4.3 repeat for the upper screw;
 - 4.4 remove the instrument from panel, keeping it horizontal;

WARNINGS: the screwdriver used should be the Pozidriv 1 (PZD1) Phillips-head screwdriver. **Do not use motorised screwdrivers.**

3.2 Electrical connections

The instruments in the PJ32 series feature different terminals for the connections:

- the Eco versions use the traditional fixed screw terminals;
- the Top versions, on the other hand, feature removable terminals with two types of cable connection blocks: screw, or by crimping.

The versions with removable terminals offer considerably simplified connection of the instrument, both for installation and maintenance. Furthermore, connection errors are avoided, as the three connection blocks have a different number of pins.

3.2.1 Power supply

The plug-in instruments are connected to the power supply using terminals 8 and 9. The voltage supplied to these terminals must correspond to the value on the instrument's connection label within the tolerance indicated in the chapter "Technical Specifications". The values are 230 Vac, 115 Vac and 12 Vac/Vdc, according to the code. The electrical insulation featured in the instrument, for the versions with mains power supply (230Vac and 115Vac), corresponds to reinforced insulation. The versions with 12Vac/Vdc power supply do not feature insulation. To guarantee correct operation during voltage drops, all the plug-in instruments feature low power operation: below a certain threshold the current supplied to the display is gradually reduced, up to the total switching off of the display and LEDs. All the other functions are guaranteed within the maximum allowed voltage drop limits; in particular, the status of the relay is maintained. On return of the normal power supply conditions, the display and the LED are reset.

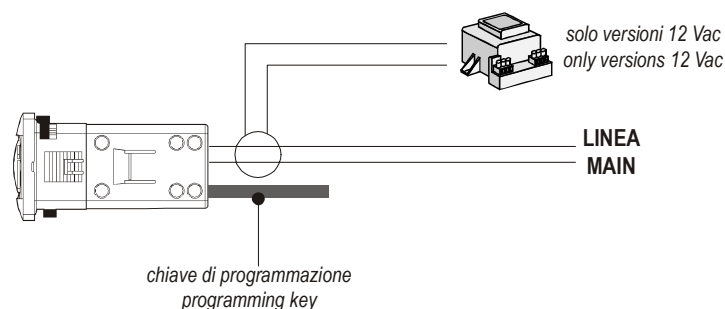

Fig. 3.2.1.1

3.2.2 Special warnings

For the direct connection of the instruments and the layout and checking of the wiring, the following warnings must be carefully read and the diagrams adhered to; errors in connection can cause danger to the safety of the user and damage the instruments and connected components. Also remember that the units must be fitted with all the electromechanical safety devices required to ensure correct operation and the complete safety of the user and of the controlled unit.

For the 12 Vac versions, if the power supply available:

- **is mains power**, a safety transformer is required (CAREL code TRA12VDE01 or TRA12VDE00) to guarantee the double insulation between the power supply and the low voltage electronics inside. If required, the protective fuse placed in series with the primary (32 mA, for code TRA12VDE00) is indispensable. The connection between the transformer and the instrument must be as short as possible;
- **is already low voltage, but not 12 Vac**, a suitably rated adapting transformer must be used: double insulation between primary and secondary, and suitable surge features on the primary (2000 V for applications in industrial environments);
- **is 12 Vac**, the instrument can be powered directly, evaluating the following conditions. The power line must not be connected to the actuators and must not be near other connections which may cause high intensity disturbance. In case of doubt, and to guarantee conformity to electromagnetic immunity standards, an insulating transformer, with the characteristics described in the previous point, is recommended.

If more than one control with a 12 Vac power supply is connected to the same transformer, the polarity of the wiring must be checked, in the sense that each terminal of the transformer must be connected to the same terminal of all the controls. In this case, conformity to the EMI standards must be evaluated by the manufacturer/installer.

3.2.3 General warnings – installation and connection environments

Avoid mounting the boards in environments with the following characteristics:

- relative humidity over 90% or presence of condensate;
- heavy vibrations or knocks;
- exposure to continuous jets of water;
- exposure to aggressive and polluting atmospheric agents (e.g.: sulphur and ammonia gases, saline mist, smoke) which may cause corrosion and/or oxidation;
- high magnetic and/or radio-frequency interference (thus avoid installation near transmitting antennae);
- exposure to direct sunlight and atmospheric agents in general;
- large and rapid fluctuations in ambient temperature;
- environments where explosives or mixes of inflammable gases are present;
- exposure to dust (formation of corrosive patina with possible oxidation and reduction of insulation);

The following warnings must be **followed** for connection:

- electrical power supply other than that prescribed may seriously damage the system;
- use cable ends that are suitable for the terminals. Loosen each screw and insert the cable end, then tighten the screws. On completing the operation, tug the cables lightly to check they are sufficiently tight;
- separate the probe signal and digital input cables from inductive loads and power cables, to avoid any electromagnetic disturbance. **Never lay power cables and probe cables in the same cable conduits (including those for the electrical cables).** Do not install the probe cables in the immediate vicinity of power devices (contactors, thermal-magnetic devices or other);
- reduce the length of the sensor cables as much as possible, and avoid spirals around power devices. The probes must be connected using shielded cables (minimum cross-section for each lead: 0.5 mm²);
- the probes can be installed up to a maximum distance of 100 m from the controller. To extend the distance of the probes, use cables with a minimum cross-section of 1 mm², shielded where possible. In this case, the shield must be connected to the common of the probe. Do not earth the other end of the shield (the sensor end);
- only use IP67 probes as end defrost probes; place the probes with the vertical bulb upwards, so as to assist the drainage of any condensate. Remember that the thermistor temperature probes (NTC or PTC) have no polarity, so the order of connection of the ends is not important;
- avoid direct contact with the internal electronic components.

3.2.4 Electrical connections, PJ32

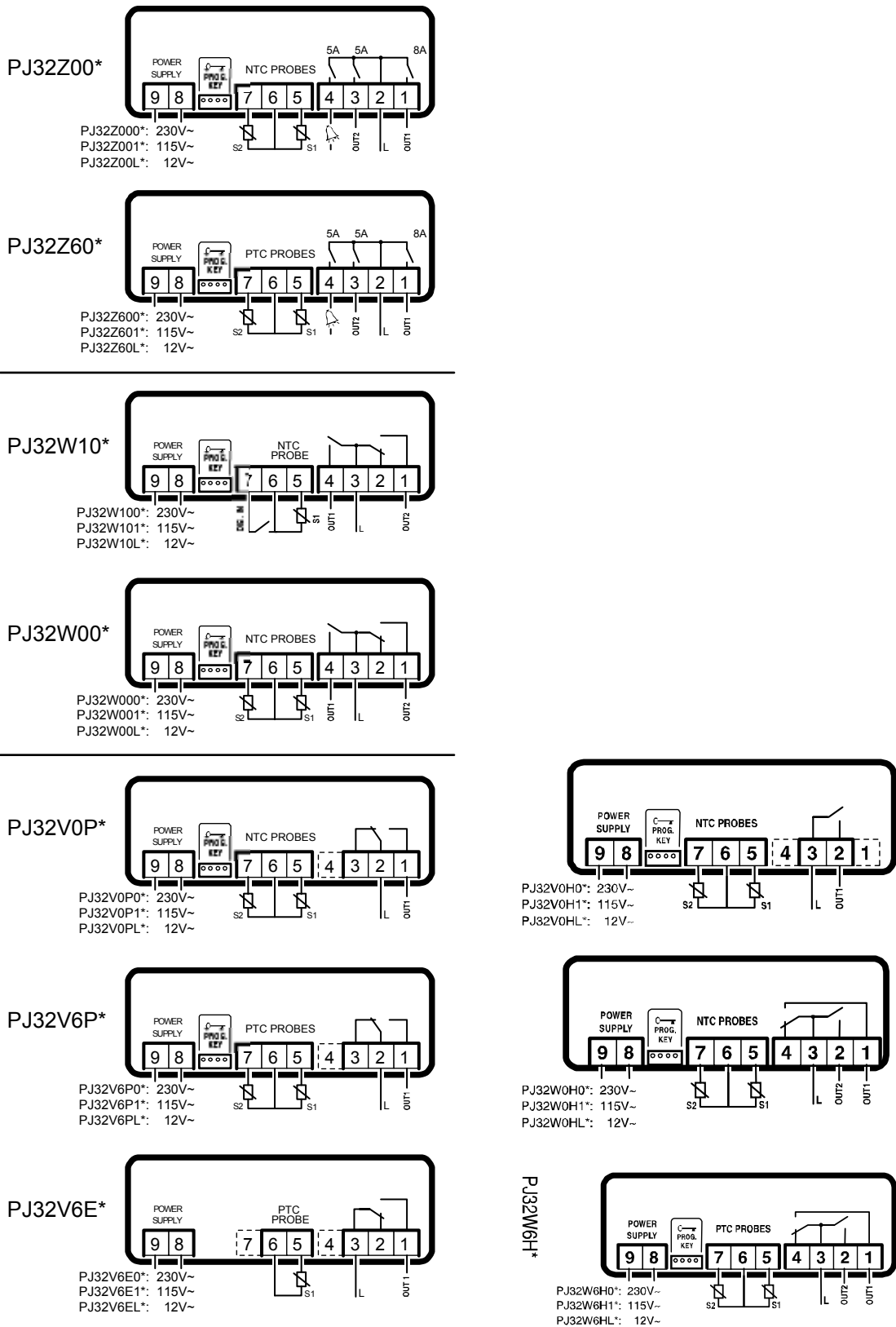

Fig. 3.2.4.1

Warnings:

- before connecting the power, check the correct value of the power supply shown on the label of the instrument;
- all models use NTC probes, except for the PJ32*6*, which uses PTC probes;
- in the models and configurations that feature an alarm signal relay, this may can be set as normally energised or normally de-energised using parameter **H1**.

4. PARAMETERS - MODIFICATION





The instruments in the PJ32 series are managed by a microprocessor which allows the operation of the control to be adjusted to effective needs. For this purpose, there are special **operating parameters**. These parameters have been grouped into two families:

- **frequent** parameters (hereafter indicated as type **F**);
- **configuration** parameters (type **C**), whose selection is protected by a code, called the password, to prevent unwanted tampering. The parameters can be modified from the front keypad, as described below.





4.1 Modifying the set points and differentials

The instrument is pre-set with a set point of 4 °C. This can be modified as follows:

Modifying set point 1:









1. press  for at least one second;
2. the display shows the code of the set point to be modified (°1);
3. press  to display the value of the set point;
4. after an instant, the previously set value will start flashing;
5. increase or decrease the set point using the  and/or  buttons, until displaying the desired value;
6. press  again to confirm the new value.

Modifying set point 2 (only if available):

1. press  for at least one second;
2. the display shows the code of the set point to be modified (°2). If the second set point is not available, the code °1 will be displayed and only set point 1 will be able to be modified;
3. press  to display the value of the set point;
4. after an instant, the previously set value will start flashing;
5. increase or decrease the set point using the  and/or  buttons, until displaying the desired value;
6. press  again to confirm the new value.

Setting the differentials (regulator hysteresis - parameters P1 and P2).

In the instrument is pre-programmed a differential of 3 degrees for each set point. May be modified as follows:



1. press  for at least 5 seconds (*);
2. the display shows the code of the first modifiable parameter (PS);
3. press  or  until displaying the code **P1**, to modify the differential associated with set point 1, or the code **P2** to modify the differential associated with set point 2 (if available);
4. press  to display the associated value;
5. increase or decrease the value using the  and/or  buttons, until displaying the desired value;
6. press  again to temporarily confirm the new value and display the next parameter code;
7. press  for 5 seconds to save the new value and exit the parameter modification procedure.

(*) if an alarm is active, briefly press the  button to mute the signal (relay or buzzer) before accessing the parameter modification procedure.





Warning: parameters **P1** and **P2** are normally visible on level F; if this is not the case, the password must be entered (as for accessing type C parameters).

4.2 Accessing the parameters

To access the type **F** parameters:









1. press the  button for more than 5 seconds (see (*) on previous page);
2. the display shows the code of the first modifiable parameter (**PS**);
3. use the  and/or  buttons to scroll all the type **F** parameters.

To access the type **C** parameters:

1. access the type **F** parameters, select parameter **PS** (password) using the  button;
2. the display shows 00;
3. press the  or  button until 22 is displayed (value of the password);
4. confirm using  ;
5. the display shows the code of the first modifiable parameter (all **F** and **C** parameters are visible).



4.3 Modifying the parameters

After having displayed the first parameter, either type **C** or type **F**, proceed as follows:



1. press  or  to reach the parameter which needs to be modified;
2. press  to display the associated value;
3. increase or decrease the value using the  or  buttons, until the desired value is displayed;
4. press  to **temporarily** save the new value and return to the display of the parameter code;
5. press  or  again to reach the next parameter which needs to be modified; repeat the operation from point 2.

4.4 Saving the new values assigned to the parameters and exiting

Press the  button for 5 seconds to definitively save the new values.

IMPORTANT WARNING: only pressing the  button for 5 seconds moves from the temporary to the definitive saving of the modifications. Therefore, if power is disconnected from the instrument before pressing , all the modifications made and temporarily saved will be lost.

4.5 Exiting the procedure without modifying the parameters

1. do not press any button for at least 60 seconds (exit by TIME OUT). In this way, the instrument returns to normal operation without saving any of the modifications to the parameters; alternatively
2. select the parameter **PS**, enter using , and when the value displayed is 00 press  again.

5. PARAMETERS – DESCRIPTION

5.1 Parameters - summary table

probe parameters		type	min.	Max.	unit of m.	def
/2	measurement stability	C	1	15	-	6
/4	select probe displayed (0 = S1, 1 = S2)	F	0	1	-	0
/5	display in °C/°F (0=°C, 1=°F)	C	0	1	-	0
/6	probe S2 reading	F	-	-	°C/°F	-
/C	room probe calibration x10 (tenths of a degree)	F	-127	+127	°C/°F	0.0

regulator parameters		type	min.	max.	unit of m.	def
P1	regulator 1 differential (0=0.5 °C)	F	0	+19	°C/°F	3
P2	regulator 2 differential (0=0.5 °C)	F	0	+19	°C/°F	3

regulator parameters		type	min.	max.	unit of m.	def
r1	regulator 1 mode (0 = Direct / 1 = Reverse)	C	0	1	-	0
r2	regulator 2 mode (0 = Direct / 1 = Reverse)	C	0	1	-	0
r3	minimum set point allowed	C	-50	r4	°C/°F	-50
r4	maximum point allowed	C	r3	+150	°C/°F	60
r5	regulator 2 probe (0 = S1, 1 = S2)	C	0	1	-	0

regulation timings		type	min.	max.	unit of m.	def
c0	output activation delay at instrument on	C	0	199	sec	0
c1	minimum on time for the regulation outputs	C	0	15	min	0
c2	minimum off time for the regulation outputs	C	0	15	min	0
c3	regulators start-up interlock	C	0	1	-	0
c4	minimum time between the activation of two outputs	C	0	199	sec	0

alarm parameters		type	min.	max.	unit of m.	def
A0	alarm differential (0=0.5 °C)	C	0	+19	°C/°F	2
AL	low temperature alarm threshold	F	-50	AH	°C/°F	-50
AH	high temperature alarm threshold	F	AL	+150	°C/°F	150
At	temperature alarm delay	C	0	199	min	0
Ad	external alarm detection delay	C	0	15	min	0

digital input parameters		type	min.	max.	unit of m.	def
dI	digital input operating mode	C	0	2	-	0

other parameters		type	min.	max.	unit of m.	def
H0	reserved: do not modify	C	0	199	-	1
H1	alarm signal output mode (0= OFF when alarm active)	C	0	1	-	0
H2	out2 output mode (0= alarm, 1= regulation)	C	0	1	-	0
H3	disable keypad (0= disabled)	C	0	1	-	1
H4	disable buzzer (1= disabled)	C	0	1	-	0
H5	identification code	F	-99	99	-	10
t	reserved: do not modify	F	-127	127	-	-

Following is a detailed description of each parameter, indicating the versions it is available in and the possible values. Furthermore, the **default value** (def.) is listed, that is the value assigned to the parameter in the factory.

5.2 Classification of the parameters

The parameters, as well as being divided by type, are also grouped in logical categories identified by the first letters of the parameters themselves. Following is a list of the existing categories, with the meaning and identifying letters.

PS	indicates the password, this must be entered to access the configuration parameters (C)
category	description
/	temperature probe management parameters
P	temperature differential parameters
r	regulator parameters
c	regulation timings management parameters
A	alarm management parameters
d	digital input parameters
H	general configuration parameters

Table. 5.2.1

5.3 The password PS

This is deliberately included to complicate access to type C parameters, so as to prevent accidental or unauthorised modifications. Type C parameters are in fact those which modify the configuration of the controller. Once having entered the configuration parameters section using the password, the controller also allows, for convenience, the type F parameters to be modified. When displaying the type F parameters, type C parameters are accessed as follows:

1. select the password parameter **PS**;
2. enter and confirm the value 22, corresponding to the value of the password;
3. all the parameters, F and C, can now be selected on the display.

5.4 / = temperature probe management parameters

	parameters probe	type	min.	max.	uom	def
/2	measurement stability	C	1	15	-	6
/4	select probe displayed (0= S1, 1= S2)	F	0	1	-	0
/5	display in °C/°F (0= °C, 1= °F)	C	0	1	-	0
/6	probe S2 reading	F	-	-	°C/°F	-
/C	room probe calibration (tenths of a degree)	F	-12.7	+12.7	°C/°F	0.0

Table. 5.4.1

/2: measurement stability

This defines the coefficient used to stabilise the temperature measurement. Low values assigned to this parameter offer the prompt response of the sensor to variations in temperature; the reading is however more sensitive to disturbance. High values slow down the response but guarantee greater immunity to disturbance, that is, a more stable and more precise reading. The setting is also used also for the second probe, if present. Values from 1 to 15. Def.: 6. Available on all models.

/4: select probe displayed, S1 or S2

For instruments with two probes this parameter selects whether to display the temperature of the probe **S1** or the probe **S2**. The probe **S2** can be used for display only, or alternatively can be associated with the second set point when this is available and used. The parameter /4 only selects the value to be displayed, all the other display and control modes remain unchanged. In the versions with just one probe (room), the parameter, when present, must always be zero (0). Def.: 0, display room probe **S1**. Available on models with two probes.

Warning: if the second probe is not used, it must be disabled by setting /4= 0 and **r5** = 0, to avoid the signal **E1** (probe alarm).

/5: select °C or °F

Defines the unit of measure used for the control and the display.

0= degrees Centigrade, 1= degrees Fahrenheit.

Warning: when changing from one unit of measure to the other, the values of the temperature parameters are not converted so they must be modified accordingly.

Def.=0, operation in degrees Centigrade. Available on all models.

/6: probe S2 reading

Displays the temperature measured by probe S2. "0" is displayed if there is a probe error (disconnected or short-circuited).

/C: calibration or calibration offset

This parameter allows the temperature measured by the probe **S1** on the display to be corrected. The value assigned to this parameter represents the correction tenths of a degree: in fact the temperature measured by probe S1 is added to (positive value) or subtracted from (negative value). For example, if the temperature displayed needs to be decreased by 2.3 degrees, set /C=-23.

The calibration offset can range from -127 to +127, with a corresponding variation in the reading between -12.7 and +12.7 (°C/°F). The parameter does not act on probe S2 (on all the models with two probes). Def.: 0.0 (no offset to probe reading). Available on all models.

5.5 P = temperature differential parameters

	controller parameters	type	min.	max.	uom	def
P1	regulator 1 differential (0=0.5°C)	F	0	+19	°C/°F	3
P2	regulator 2 differential (0=0.5°C)	F	0	+19	°C/°F	3

Table. 5.5.1

P1: regulator 1 differential

Sets the value of the temperature differential (hysteresis) used in the control associated with set point 1. It is set in °C or °F. A 'narrow', that is, numerically small differential, guarantees a room temperature which stays close to the *set point*, yet with frequent activation and deactivation of the actuator. The life of the actuator can still be protected by suitably setting the parameters which limit the number of activations per hour and the minimum off time (see C parameters). **P1** values lower than 3 should not be set.

Def.: **P1**=3

Available on all models.

P2: regulator 2 differential

Sets the value of the temperature differential (hysteresis) used in the control associated with set point 2. It is set in °C or °F. A 'narrow', that is, numerically small differential, guarantees a room temperature which stays close to the *set point*, yet with frequent activation and deactivation of the actuator. The life of the actuator can still be protected by suitably setting the parameters which limit the number of activations per hour and the minimum off time (see C parameters). **P2** values lower than 3 should not be set.

Def.: **P2**=3

Available on all models with 2 or 3 relays.

5.6 r = regulation parameters

	controller parameters	type	min.	max.	uom	def
r1	regulator 1 mode (0= Direct / 1= Reverse)	C	0	1	-	0
r2	regulator 2 mode (0= Direct / 1= Reverse)	C	0	1	-	0
r3	minimum set point allowed	C	-50	r4	°C/°F	-50
r4	maximum set point allowed	C	r3	+150	°C/°F	60
r5	regulator 2 probe (0= S1, 1= S2)	C	0	1	-	0

Table. 5.6.1

r1: regulator 1 mode

Determines the operating mode for regulator 1, associated to the **set point 1** and **S1**.

With reference to the drawing below, in *direct* mode (**r1** = 0) the differential is placed "on the right" of the **set point 1**, in *reverse* mode (**r1** = 1) it is placed "on the left":

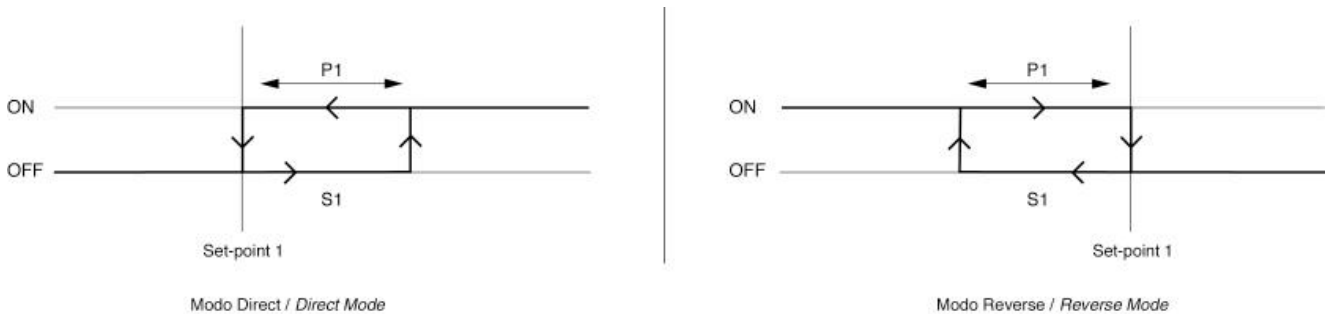

Def.: 0 Available on all models.

r2: regulator 2 mode

Determines the operating mode for regulator 2. In the models that feature two probes, the operation is based on the probe **S1** (**r5** = 0) or **S2** (**r5** = 1).

With reference to the drawing below, in *direct* mode (**r2** = 0) the differential is placed "on the right" of the set point 2, in *reverse* mode (**r2** = 1) it is placed "on the left":

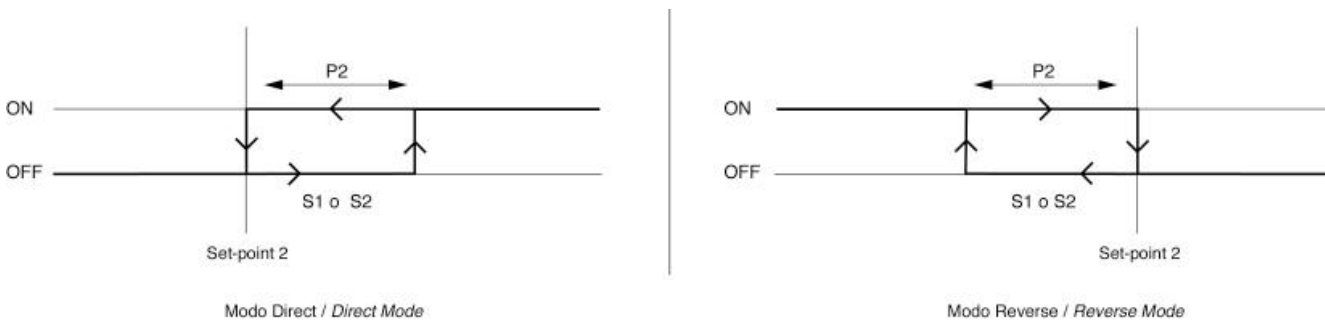

Def.: 0, Available on all models with 2 or 3 relays.

r3: minimum set point allowed

Determines the minimum value which can be set for the set point. This parameter prevents the user from setting the set point lower than the value indicated by **r3**. Def.: -50

r4: maximum set point allowed

Determines the maximum value which can be set for the set point. This parameter prevents the user from setting the set point higher than the value indicated by **r4**. Def.: +60

r5: regulator 2 probe

Selects the probe to be used by regulator 2 (that is, the regulator associated with set point 2) for the operation of the connected load. If set to zero, probe **S1** is used, otherwise probe **S2** is used.

Def.: 0. Available in the models with two probes.

5.7 c = regulation timings management parameters

control times		type	min.	max.	uom	def
c0	output activation delay at instrument on	C	0	199	sec	0
c1	minimum on time for the regulation outputs	C	0	15	min	0
c2	minimum off time for the regulation outputs	C	0	15	min	0
c3	regulators start-up interlock	C	0	1	-	0
c4	minimum time between the activation of two outputs	C	0	199	sec	0

Table. 5.7.1

c0: output activation delay from instrument on

When power supply is applied, the activation of the regulation outputs is delayed by a time (minutes) equal to the value set for this parameter. This delay allows the load to be protected against repeated starts in the case of frequent power failures. For example, setting **c0=6** forces the load to wait 6 seconds before starting from when power returns. In the case, for example, of systems with many units, parameter **C0** can also be used to avoid simultaneous starts of the controls, by simply setting a different value for **C0** on each regulator.

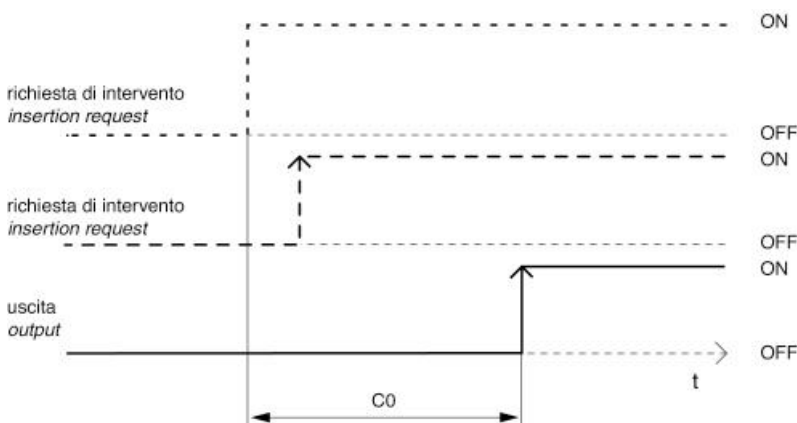

Fig. 5.7.1

Def.: **c0=0** (no delay for the activation of the control outputs when the instrument is switched on).

Available on all models.

Warning: this parameter should not be set to "1".

c1: minimum on time for the regulation outputs

Sets the minimum activation time for the regulation outputs. During normal operation, the load is not stopped unless it has been on for at least the minimum time set using **c1**. This parameter is useful for example for minimising wear on the actuator.

Def.: **c1**=0 (no minimum on time is set).

Available on all models.

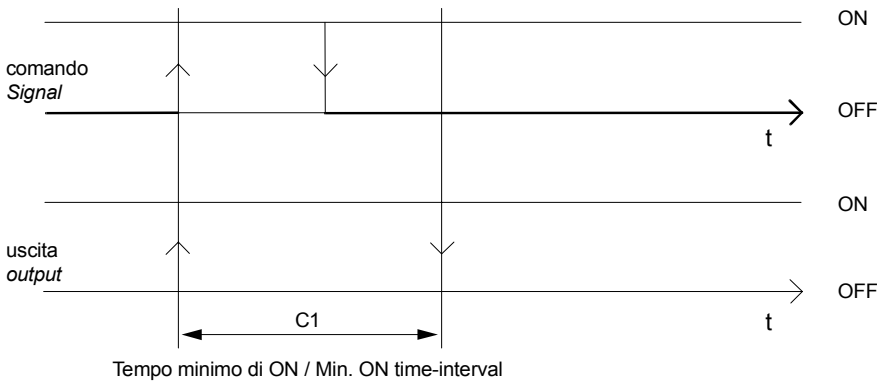

Fig. 5.7.2

c2: minimum OFF time for the regulation outputs

Sets the minimum deactivation time for the control outputs. The output cannot be activated unless it has been off for at least the time set using **c2**. This parameter is useful for minimising wear on the actuator.

Def.: **c2**=0 (no minimum off time is set).

Available on all models.

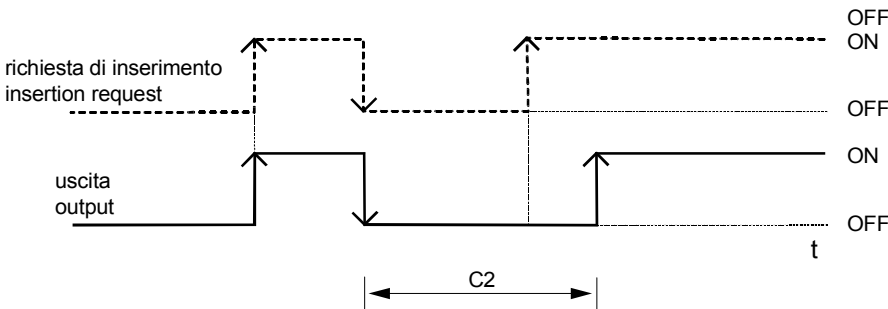

Fig. 5.7.3

c3: regulators start-up interlock

If set to 1, this function prevents the output associated with on set point from being activated if the output associated with the other set point is not off, even if the temperature would require this. This may be useful, for example, if one output is set in "direct" mode and the other in "reverse" mode, to avoid both being on at the same time even if the set point would require.

Warning: if both the outputs are on when **c3** is set to 1, these will remain on. The interlock function will be active when the instrument is next switched on.

Def.: **c3**=0 (no interlock is set).

Available on all models with 2 or 3 relays.

c4: minimum time between the activation of two outputs

Defines a minimum time interval between the activation of the two regulation outputs: if, for example, output 2 is active and the controller requires as well the activation of output 1, this will not be activated until at least a time of **c4** seconds has elapsed from when output 2 was activated. Note that if both outputs are signalled to activate at the same time, output 2 will be delayed. This function may be useful, for example, to avoid the simultaneous activation of loads with a high starting current. This parameter is used if **c3**=0.

Def.: **c4**=0 (no delay is set between starts). Available on all models with 2 or 3 relays.

5.8 A = alarm management parameters

	alarm parameters	type	min.	max.	unit of m.	def
A0	alarm differential (0= 0.5 °C)	C	0	+19	°C/°F	2
AL	low temperature alarm threshold	F	-50	AH	°C/°F	-50
AH	high temperature alarm threshold	F	AL	+150	°C/°F	150
At	temperature alarm delay	C	0	199	min	0
Ad	external alarm detection delay	C	0	15	min	0

Table 5.8.1

A0: alarm differential

This represents the differential used to activate the high and low temperature alarms (**AL** and **AH**, see figure below). In the case of an alarm, as seen in the figure, the value of **A0** determines the actual activation and deactivation points for the temperature alarms. The alarm resets automatically once ended the alarm event: it is not necessary to operate to the control keypad.

Def.: 2 °C. Available on all models.

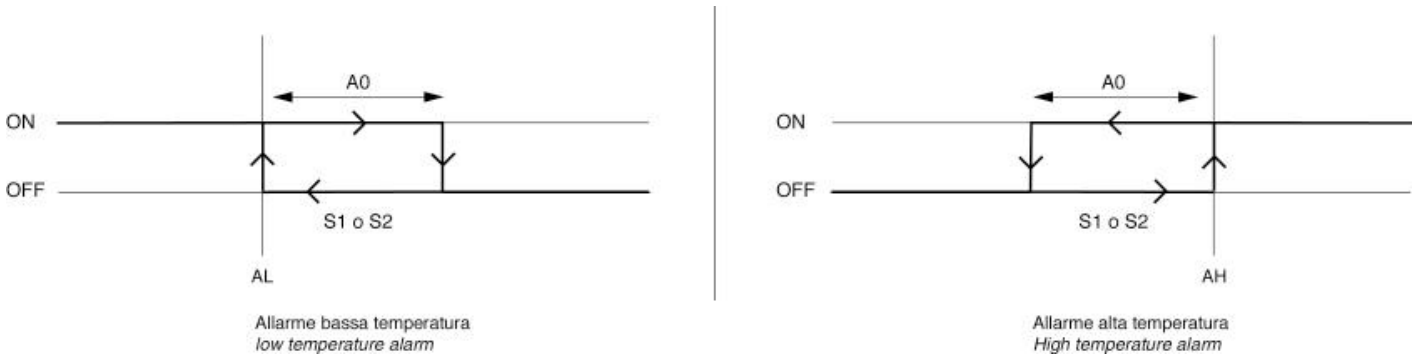

AL: low temperature alarm

Selects, in absolute value, the low temperature alarm threshold. When the temperature measured by probe **S1** falls below the set temperature, the "LO" alarm is signalled and the alarm relay is activated, if available. This alarm is also detected for probe **S2** if this is currently associated with an output "OUT2" (**r5= 1**). The low temperature alarm has automatic reset. This means that if the temperature returns above the threshold value **AL+A0**, the alarm signal is automatically cancelled. The deactivation of the alarm does not generate a signal. Def.: **AL**= -50. Available on all models.

AH: high temperature alarm

Selects in absolute value, the high temperature alarm threshold. When the temperature measured by probe **S1** rises above below the set temperature, the "HI" alarm is signalled and the alarm relay is activated, if available. This alarm is also detected for probe **S2** if this is currently associated with an output "OUT2" (**r5= 1**). The high temperature alarm has automatic reset. This means that if the temperature returns below the threshold value **AH-A0**, the alarm signal is automatically cancelled. The deactivation of the alarm does not generate a signal. Def.: **AH**= 150. Available on all models.

At: temperature alarm delay

Indicates how many minutes the temperature can remain beyond the set alarm thresholds (parameters **AL** and **AH**) without the alarm is signalled. Every time the temperature falls within the limits prefixed by **AL** and **AH**, the delay takes place entirely.

Setting a delay to signal of the temperature alarms may help eliminate false alarms due to interference on the probe signal or situations lasting a short time (for example, opening the cold room door briefly). Def.: **At**= 0 (instant temperature alarm). Available on all models.

Ad: external alarm detection delay (digital input)

Sets the delay (in minutes) for detecting the external alarm when **dI**= 1.

Def.: **Ad**= 0. Available on all models.

5.9 d = digital input parameters

parameters digital input		type	min.	max.	uom	def
dI	digital input operating mode	C	0	3	-	0

Table. 5.9.1

dI: digital input operating mode

Sets, for the instruments where fitted, the function of the digital input:

dI	Function	Description															
0	Not used	The status of the digital input is ignored															
1	Alarm	When the digital input becomes open, after a delay set by parameter Ad , the alarm from digital input " IA " is signalled, the alarm relay, if available, is activated, and the regulation outputs are deactivated without observing the minimum on time c1 . As soon as the alarm condition ceases, the control functions restart as normal respecting the configured timings.															
2	set point switching	<p>This function can be activated in the units with two relays when the second output is used as a signal relay (H2 = 0) and allows the set point and the settings normally used by output out2 to be used by output out1,</p> <p>The table below summarises the settings according to the status of the digital input:</p> <table border="1" data-bbox="459 689 1417 786"> <thead> <tr> <th>Input</th> <th>set point</th> <th>Differential</th> <th>Mode</th> <th>Sonda</th> </tr> </thead> <tbody> <tr> <td>open</td> <td>1</td> <td>P1</td> <td>r1</td> <td>S1</td> </tr> <tr> <td>closed</td> <td>2</td> <td>P2</td> <td>r2</td> <td>S1 or S2, see r5</td> </tr> </tbody> </table> <p>Table. 5.7.1</p> <p>The mode dI= 2 is useful, for example, to use the digital input for changing from heating to cooling, or to change the set point day/night.</p> <p>Warning: when the digital input changes status, the delays set for parameters c1 and c2 are ignored.</p>	Input	set point	Differential	Mode	Sonda	open	1	P1	r1	S1	closed	2	P2	r2	S1 or S2 , see r5
Input	set point	Differential	Mode	Sonda													
open	1	P1	r1	S1													
closed	2	P2	r2	S1 or S2 , see r5													

Table. 5.9.2

Def.: **dI**=0, digital input not used. Parameter available on models with digital input.

5.10 H = other settings

	other parameters	type	min.	max.	uom	def
H0	reserved	C	0	199	-	1
H1	alarm signal output mode (0= off when alarm active)	C	0	1	-	0
H2	out2 output mode (0= alarm, 1= regulation)	C	0	1	-	0
H3	disable keypad (0= disabled)	C	0	1	-	1
H4	disable buzzer (1= disabled)	C	0	1	-	0
H5	identification code	F	-99	99	-	10
T	reserved	F	-127	127	-	-

Table. 5.10.1

H0: reserved parameter

The parameter H0 is reserved. Never modify the value.

Def.: **H0**= 1. Available on all models.

H1: alarm output mode

This parameter is used to define the operating mode of the alarm signal relay. If H1= 0, the relay is energised when no alarm is active, if H1= 1 the relay is energised when an alarm is active. The parameter has no effect on units without alarm relays.

Def.: **H1**=0, relay energised when no alarm is active.

Warning: when switching the instrument on, this relay is always de-energised for a few seconds.

H2: out2 output mode

The parameter **H2** is present only on the units with two relays, and used to set the function performed by output **out2**:

H2	out2 output mode	Description
0	Alarm	The output is used to control an alarm signal device. The operating logic may be selected by setting H1 . If the controller has no digital input or alternatively if parameter dl is set to a value other than 2 (set point switching), all the parameters corresponding to regulator 2 (set point 2 , P2 , r2 , r5 , c3) are not displayed in parameter modification mode, as they are not usable. If the model is fitted with a digital input and dl = 2 , the parameters indicated above are displayed and used as described previously.
1	Regulation	The output is used to control parameters set point 2 , P2 , r2 , r5 .

Def.: **H2**=0. Available only on the units with two relays.

H3: disable keypad

Parameter **H2** can be used to disable the modification of the set point and the other operating parameters when the instrument is located in areas which are accessible to the public.

With the **keypad disabled** (**H3**= 0), the set point and type **F** parameters cannot be modified. Their value can however be displayed. Type **C** parameters, which are password protected, can **however be modified**, following the procedure described below. The modification of parameter **PS** is always allowed.

Def.: **H3**=1. Available on all models.

H4: disable buzzer

Disables the operation of the buzzer. (**H4**= 0: buzzer enabled, **H4**= 1: buzzer disabled).

Def.: **H4**= 0 buzzer enabled. Available on PJ32S and X.

H5: ID code

This parameter, which cannot be modified through keypad, assigns the instrument an identification code that can be useful in identifying the various parameter configurations used for different models of units. Moreover, when the controller turns out from the factory, this parameter has a positive value but, if any other parameter is modified, **H5** becomes negative to show that the unit configuration has been changed in comparison with the initial values. See the paragraph "**Parameter copy key**".

Def.: **H5**= __ (value depending on the model). Available on all models. Always visible in level F.

Warning: the values from 0 to 31 are used by CAREL to identify the basic models.

t: parameter reserved

The parameter **t** is reserved. Never modify the value.

Available on all models.

6. Alarms and troubleshooting

6.1 Abnormal or special operation

The instruments in the PJ32 series are able to automatically detect the main malfunctions with the consequent activation of the following actions:

- the malfunction is signalled on the display with the corresponding alarm code. In particular, the instrument displays the alarm code and the temperature read by the probe, alternating. In the case of more than one alarm, these are displayed in sequence:
 - for some alarms the internal buzzer, if present, sounds;
 - for the same alarms as above, the alarm relay, if present and configured as an alarm output, is activated.



Pressing the button silences the buzzer and de-energises the relay, while the alarm code and red LED go off only when the cause of the alarm no longer exists. The alarm codes are shown in the following table:

alarm code	buzzer and alarm relay	alarm description	models where envisaged
E0	active	probe S1 error	all
E1	active	probe S2 error	all, if two probes are present
IA	active	external alarm, immediate or delayed by A7	all, if the digital input is present
L0	active	low temperature alarm	all
HI	active	high temperature alarm	all
EE	not active	data saving error	all

Table. 6.1.1

6.2 Description of the main signals and alarms

LED flashing

The start of the corresponding function is delayed by a timer, is awaiting an external signal or is inhibited by another procedure already in progress.

E0 flashing or on steady

probe S1 error:

- probe not working: the probe signal **S1** is discontinued or short-circuited;
- probe **S1** not compatible with the instrument; in case the probe is NTC type check that it corresponds with the characteristics shown in the paragraph "*Appendix: Temperature/resistance correlation for NTC thermistors*".

The alarm signal **E0** is on steady if this is the only alarm present (the temperature value cannot be displayed any longer), or alternatively flashes if other alarms are active, or if the second probe is displayed ($\neq 1$).

The regulation outputs "**OUT1**" and "**OUT2**", if depending on the probe **S1** are immediately disabled without complying with the minimum startup time **c1**.

E1 flashing or on steady

probe S2 error:

- probe not working: the probe **S2** signal is discontinued or short-circuited;
- probe **S1** not compatible with the instrument; in case the probe is NTC type check that it corresponds with the characteristics shown in the paragraph "*Temperature/resistance correlation for NTC thermistors*".

The alarm signal **E1** is on steady if this is the only alarm present and $\neq 1$ (the temperature value is no longer displayed), or alternatively flashes if other alarms are active, or if probe S1 is normally displayed.

The alarm is not signalled if probe **S2** is not used as the control probe.

The regulation outputs "**OUT1**" and "**OUT2**", if depending on the probe **S2** are immediately disabled without complying with the minimum startup time **c1**.

IA flashing

alarm from multifunction digital input, immediate or delayed:

- check the multifunction input and the parameters **Ad** and **d1**.

The regulation outputs are immediately disabled without complying with the minimum startup time **c1**.

L0 flashing

low temperature alarm. A probe has measured that the temperature is lower than the value set for parameter **AL** for a time higher than what indicated by the parameter **At**:

- check parameters **AL**, **A0** and **At**.

The alarm is reset automatically when the temperature returns within the set limits (see parameter **AL**).

The regulation outputs are not influenced by this alarm.

HI flashing

high temperature alarm. A probe has measured that the temperature is higher than the value set for parameter **AH** for a time higher than what indicated by the parameter **At**.

- check parameters **AH**, **A0** and **At**.

The alarm is reset automatically when the temperature returns within the set limits (see parameter **AH**).

The regulation outputs are not influenced by this alarm.

EE displayed during operation or at power on

error reading the parameters from the data memory. See the following paragraph "**Data saving error**".

All the outputs are de-energised.

6.3 Stored data error

In particular operating conditions the instrument may detect errors in the internal storage of the data. These errors may compromise the correct operation of the instrument. If the microprocessor detects a stored data error, display shows the code **EE**.

The instrument tries ciclically to reset the correct operating conditions, and this is indicated by the three dashes --- (reset) alternating with the code **EE**.

If the anomalous situation remains, the control must be replaced. If on the other hand the message disappears, the control can still be used. When the **EE** error occurs frequently and/or is hard to resolve, it is recommended to have the control checked, in that the original accuracy may not be guaranteed.



It is good practice to investigate the cause of this type of error so as to prevent it occurring again. **We ask to read carefully the chapter "INSTALLATION" and in particular the paragraphs "Special warnings" and "General warnings – installation and connection environments"**.

6.3.1 Loading the default parameters

The default values of the parameters can be restored by following the procedure described below:

- switch the instrument off;



- press and hold the  and  buttons, and switch the instrument on;
- the display shows the message - - - followed by **CF**;
- after some seconds the instrument will start working with the default configuration. Any of the F and C parameters that differ from the default configuration can be modified as desired.

IMPORTANT WARNINGS

- the procedure described above resets the instrument assigning the default value to all the parameters and set points. **As a result, all modifications made to the operating parameters will be lost;**
- given the delicacy of this operation, the procedure must be performed by specialist personnel. However, this procedure does **not damage** the instrument, but rather resets its original purchase configuration shown in chapter "**PARAMETERS – DESCRIPTION**". Therefore, if the parameters have been modified in a disorganised fashion, to the point where the control is unworkable, it can be "reset" to its original configuration.
- if a programming key is used the reset operation is much simpler, as long as the key contains the required configuration, or it can be copied from another instrument programmed in the same way..

6.4 Troubleshooting

The following table shows other anomalous operating situations which may arise in the various models.

The more frequent causes are indicated and a number of checks are suggested.

problem	cause	checks
the outputs are not activated as envisaged (signalled by LED flashing)	<ul style="list-style-type: none"> • activation delay set • minimum OFF time set • output interlock set 	check parameters c0 , c1 , c2 and c3
the temperature is over the set limits, but the alarm is not displayed and the buzzer, if present, does not sound	alarm delay set	check parameter At
the temperature read by probe S2 is over the set limits, but the alarm is not displayed and the buzzer, if present, does not sound (models with two probes)	probe S2 is not the control probe	check parameters H2 , d0
the alarm IA is signalled (multifunction input) without it actually being active	the multifunction input generates an alarm when the contact opens	check the connection of the input and that it is closed in normal operation
the alarm connected to the multifunction input is not activated	alarm delay set or parameter programming error	check if d0 = 1, check the status of the digital input and check Ad
after having modified a parameter, the controller continues to work with the old values	<p>the instrument has not updated the old value or alternatively the parameter programming procedure has not been completed correctly getting out of the programming mode, that is, by</p>  <p>pressing for 5 seconds</p>	turn the instrument off and on again, or alternatively correctly program the parameters again

Table. 6.4.1

7. Accessories supplied

7.1 Parameter copy key

Used to copy the configuration of an instrument (values set for all the parameters).

The "key" features a power button, a two-colour signal LED (red/green) and a connector for connection to the serial interface on the instrument, as shown in the figure below.

It is supplied by a 12Vdc alkaline battery, *Philips VR32*, *Duracell MN21* or equivalent.

1. When using the key, the instrument must not be powered, as the power is supplied by the key itself. The data can only be transferred between instruments with the same code.

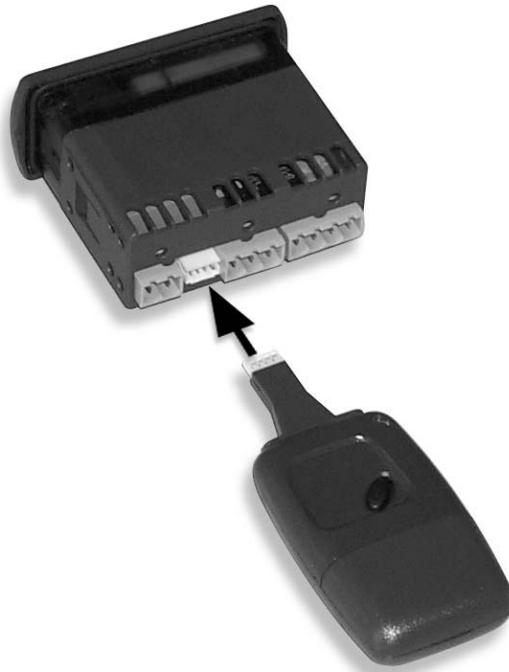

Fig. 7.1.1

The possible operations are described below:

1. **transfer the parameters from the instrument to the key ("read"):**
move the two dipswitches 1 and 2 to OFF.
2. **transfer the parameters from the key to the instrument ("write", this operation is only possible if the parameters stored on the key were read from an instrument with the same code) :**
move dipswitch 1 to OFF and dipswitch 2 to ON.
3. **H5 setting:** this is used exclusively to return the **H5** sign to a positive value (see the description of the parameter). Dipswitch 1 must be moved to ON and dipswitch 2 to OFF.

Once the desired function has been set, press and hold the start button to perform the required operation. The two-colour LED signals the current status of the operation, indicating the progress and the completion of the data transfer, as well as any errors. The operation may last up to around 12 seconds, during which time the instrument remains in a "suspended" situation. Once the data transmission has been completed, the instrument starts operating in normal mode.

Note: release the button as soon as the transfer operation is complete so as to extend the life of the battery in the key as long as possible.

The two-colour LED shows the following signals:

- **on** → the LED is *dull red* for a short period of time
- **data transfer** → the LED is *bright red*
- **Warning: the button must *not* be released during this period**
- **operation completed successfully** → the LED is *green*.
- **error during the operation** → the LED *flashes red and green alternately*

in this case, one of the following errors has occurred:

1. disconnection or no response from the instrument;
2. low battery power;
3. instrument model not compatible;
4. data transfer error;
5. instrument EEPROM error.

For complete details of the cause of the error, refer to the instruction sheet provided with the key. After having resolved the problem, repeat the previous operation.

8. Technical specifications

models		PJ32V	PJ32W0	PJ32W1	PJ32Z
power supply					
PJ32***L**	12 Vac $\pm 10\%$, 50/60Hz (12...16Vdc)	•			
PJ32***1**	115 Vac, +10 to -15%, 50/60Hz				
PJ32***0**	230 Vac, +10 to -15%, 50/60Hz	•	•	•	•
rated power (VA)		3			
precision of the instrument (with reference to the type of probes)					
NTC CAREL		$\pm 1\text{ }^{\circ}\text{C}$ (-50T90)			
PTC		$\pm 3\text{ }^{\circ}\text{C}$ (-50T90), $\pm 6\text{ }^{\circ}\text{C}$ (+90T150)			
type of probe S1					
CAREL NTC (10 K at 25°C) – regulation range:-50T90 °C (-50T127 °F)		•	•	•	•
PTC (985 Ω at 25°C) – regulation range:-50T150 °C (-50T127 °F)		•			•
type of probe S2					
CAREL NTC (10 K at 25°C) - regulation range: -50T90°C (-50T127°F)		•	•	•	•
PTC (985 Ω at 25°C) - regulation range: -50T150°C (-50T127°F)					•
temperature range					
operating conditions: -10T50°C, <80% r.H. non-condensing		•	•	•	•
storage conditions: -20T70°C, <80% r.H. non-condensing		•	•	•	•
user interface					
LED display with 2 and a half digits		•	•	•	•
signal buzzer:		•			
indication corresponding to set point 1		•	•	•	•
indication corresponding to set point 2			•	•	•
second probe indication				•	•
special functions					
Multifunction input			•		
Multifunction output for alarm relay			•	•	•
programming key connection		Top	Top	Top	Top
keypad lock		•	•	•	•
mechanical characteristics					
dimensions (mm): 36x81x65		•	•	•	•
click-on fastening to bracket		•	•	•	•
screw fastening from front panel		Top	Top	Top	Top
type of environmental pollution: normal		•	•	•	•
electrical specifications					
relay outputs: action type 1C		•	•	•	•
index of protection IP54 for panel installation		•	•	•	•
connections: screw terminals for cables with min. 0.5 mm ² and max. 1.5 mm ² cross-section, and up to 2.5 mm ² for crimped terminals		•	•	•	•
definition as per UL approval: 250 Vac 12/8/5 A res. 5/2/1 FLA 30/12/6 LRA					
definition as per EN60730-1: 12(2) / 6(2) / 5(1) A 250 Vac					
quality and precision					
watchdog (self-diagnostics of internal functions)		•	•	•	•

Table. 8.1

8.1 Characteristics of the relays used

electrical specifications of the relays used in the various models	max. current 16A resistive	max. current 8A resistive	max. current 5A resistive	max current 16 A resistive 2 HP
maximum peak current	30 A	12 A	6 A	72 A
maximum switchable resistive current	12 A	8 A	5 A	16 A
maximum switchable output (250 Vac)	3000 VA	2000 VA	1250 VA	4000 VA
maximum inductive load at 250 Vac	4 A (cos $\varphi=0.7$)	2 A (cos $\varphi=0.8$)	2 A	12 A (cos $\varphi.=0.7$)
maximum switchable voltage	250 Vac	250 Vac	250 Vac	250 Vac
definition as per VDE0435	16(2) A 250 Vac	8(2) A 250 Vac	5(2) A 250 Vac	16A 250 Vac
definition as per VDE0461	12(2) A 250 Vac	6(4) A 250 Vac		12(12) A 250 Vac
UL definition (*) (UL approval of the instrument)	250 Vac 12 A res. 5FLA 30LRA	250 Vac 8 A res. 2FLA 12LRA	250 Vac 5 A res. 1FLA 6LRA	250 Vac 12 A res. 12 FLA 72LRA
definition of the instrument as per EN60730-1	12(2) A 250 Vac or 10 (4) A only NO	6(2) A 250 Vac or 8 (3) A only NO	5(1) A 250 Vac	10(10) A 250 Vac

(*) T-OFF minimum between two following motor load starting is 60 seconds or more.

8.2 Appendix: temperature/resistance correlation for NTC thermistors

The temperature probes with NTC thermistors, normally used on the PJ32 controllers, change their resistance as the temperature changes. The following table shows the electrical resistance values corresponding to the various temperatures.

Table 9.2.2 shows 3 resistance values for each temperature:

- R_{std} is the standard resistance at the temperature indicated;
- R_{min} is the minimum value;
- R_{MAX} is the maximum value.

The table can be used to check the operation of the probes against the values corresponding to the temperatures shown.

Temperature/resistance correlation for the CAREL NTC temperature probes. Rated value: 10 k Ω at 25 °C.

temperature (°C)	R_{min} (k Ω)	R_{std} (k Ω)	R_{MAX} (k Ω)
-40	181.10	188.40	195.90
0	26.74	27.28	27.83
20	11.95	12.09	12.23
50	4.08	4.16	4.24

Table. 8.2.2

For the PJ32 controllers featuring PTC probe input, refer to the table of temperature/resistance values for the CAREL PTC temperature probe.

NOMINAL VALUE: 990 Ω at 25 °C

temperature (°C)	R_{min} (Ω)	R_{std} (Ω)	R_{max} (Ω)
-40	545	562	578
0	792	807	820
20	944	952	962
50	1178	1196	1213

Tab. 8.2.3

9. Dimensions

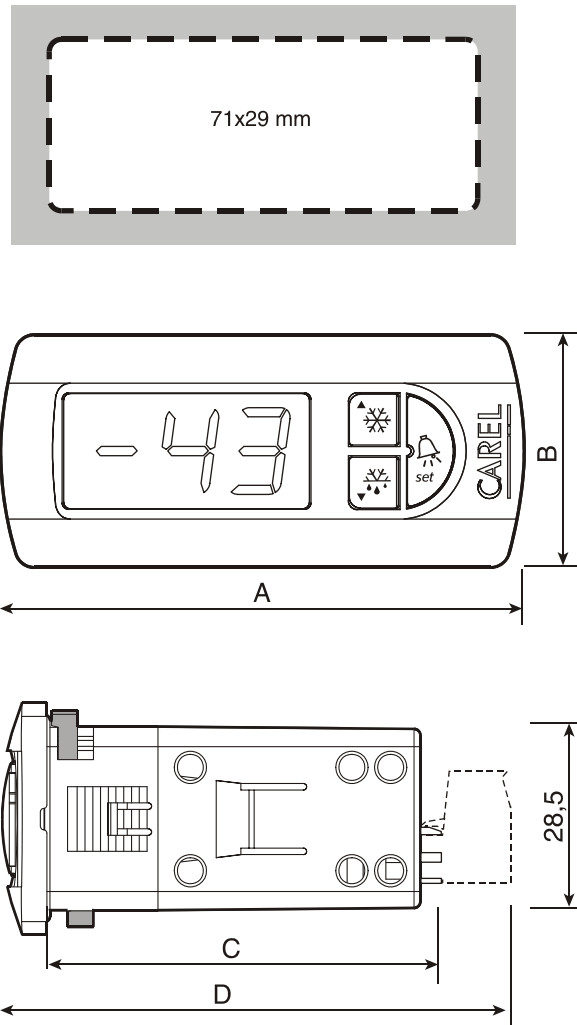

Fig. 9.1

dimensions (mm)	fixed screw terminals	removable terminals
A	81	81
B	36	36
C	68	78
D	65	65

Table. 9.1

CAREL reserves the right to modify or change its products without prior notice.

CAREL

Technology & Evolution

CAREL S.p.A.
Via dell'Industria, 11 - 35020 Brugine - Padova (Italy)
Tel. (+39) 049.9716611 Fax (+39) 049.9716600
<http://www.carel.com> - e-mail: carel@carel.com

Agency: