

# Temperature controllers

## 1/16 DIN - 48 x 48 mm

### gamma**due**<sup>®</sup> series M1-M3 lines

#### Flexible, easy and comprehensive

These two 48x48 size controllers of the gamma**due**<sup>®</sup> series, are suitable for a wide range of applications. The M1 can be used as a simple controller while the M3 performs Heat/Cool control and provides on auxiliary current transformer input. Easy configuration and a simple operating method are merged with the typical characteristics of more complex devices like:

autotune, IP65 front panel protection, serial communications, analogue retransmission output, custom linearisation, transmitter power supply, Start-up and Timer special functions.

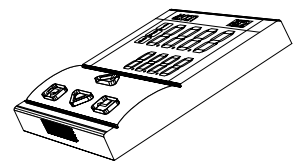
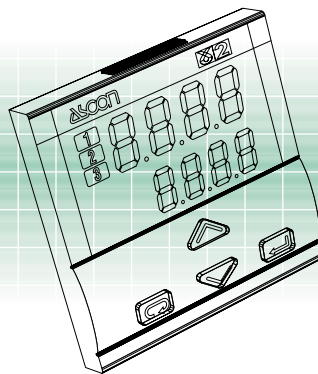
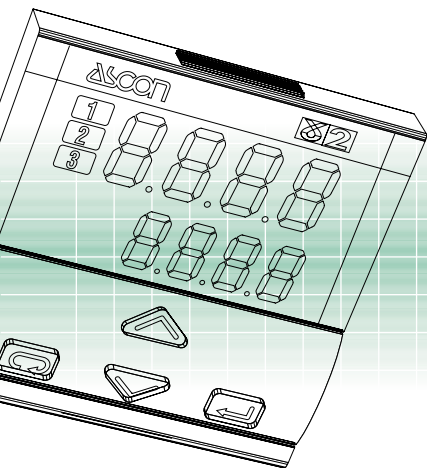
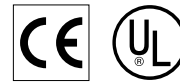

E

**ASCON spa**

20021 Bollate - (Milano) Italy - Via Falzarego, 9/11 - Tel. +39 02 333 371 - Fax +39 02 350 4243  
<http://www.ascon.it> e-mail [info@ascon.it](mailto:info@ascon.it)

ISO 9001 Certified

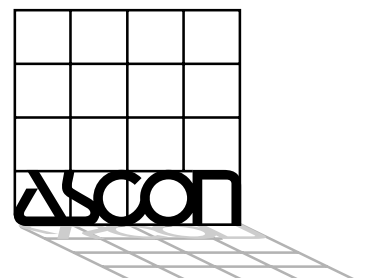



Your needs	Our solutions
Heaters failure	Heater break alarm with current transformer
Both heating and cooling functions	Heat/Cool double action
Easy replacement and quick start-up	Configuration by simple to use codes
Correct tuning for any condition	Automatic selection between two different tuning methods
Alarm signalling	Absolute, band and deviation alarms, Latching/Blocking
Interfacing with other devices	Serial communications at 9600 baud Modbus/Jbus protocol, analogue retransmission output
Quick learning	Every model has the same operating method
Ergonomic compatibility with other devices	Two colours: beige or darkgrey front panels
Environmental protection	IP65 front panel protection (indoor, dust and water protection)
Easy to use	Ergonomic keypad, clear and comprehensive display
Noise immunity	Electromagnetic compatibility
Universal input signals, linear as well as non-linear	Configurable input (TC, RTD, mA, Volt and ΔT, infrared sensor, "custom" linearisation)
Costs reduction	Built-in Timer and Start-up functions
Reliability and safety	CE compatibility, ASCON is ISO 9001 certified, 3 years warranty
Technical support	Technical application assistance from ASCON sales and after sales service

## Resources

## Operating mode

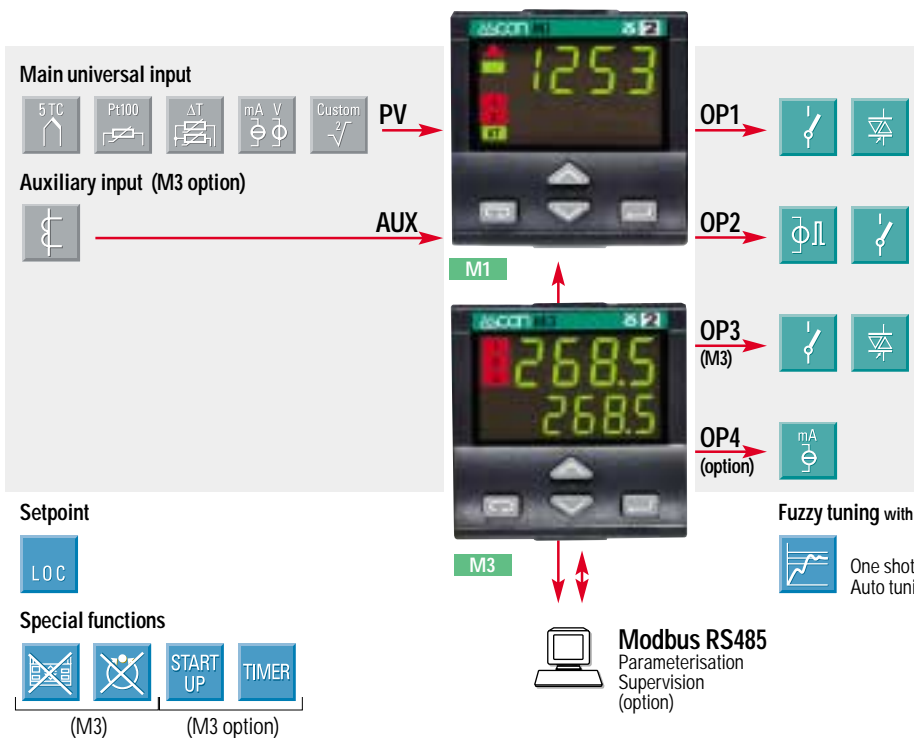

	Control	Alarms		Retransmission
0 *	Indication only			PV/SP
1	Single action	OP1	OP2 OP3 (M3)	OP4
2	Single action	OP2	OP1 OP3 (M3)	OP4
3 *	Double action	OP1 OP3	OP2	OP4
4 *	Double action	OP1 OP2		OP3 OP4
5 *	Double action	OP2 OP3	OP1	OP4

### Fuzzy tuning with automatic selection



\* Mode 0 for M1 only  
Modes 3, 4 and 5 for M3 only

## Technical data

Features at env. 25°C	Description			
Total configurability	From keypad or serial communications, the user selects: type of input - associated functions and corresponding outputs - type of control algorithm - type of output and safe conditions - alarm types and functionality - control parameter values			
PV input (for signal ranges see table 1)	Common characteristics	A/D converter with 50.000 points Update measurement time : 0.2 sec Sampling time : 0.5 sec Input shift : + 60 digits Input filter : 1...30 sec (OFF= 0)		
	Accuracy	0.25% ± 1 digit (T/C and RTD) 0.1% ± 1 digit (mA and mV)	Between 100 and 240V~ error is minimal	
	Resistance thermometer (for ΔT: R1+R2 must be <320Ω)	Pt100Ω at 0°C (IEC 751) °C /°F selectable	2 or 3 wire connection	Line: 20Ω max (3 wire) Thermal drift 0.35°C/10°C env. T. <0.35°C/10 Ω line exist.
	Thermocouple	L,J,T,K,S (IEC 584) °C /°F selectable	Internal cold junction compensation	Line: 150Ω max Thermal drift <2μV/°C env. T. <5μV/10Ω line resist.
	DC input (current)	0/4...20mA with 2.5Ω ext. Shunt Rj > 10MΩ	Engineering units, floating decimal point, Low Range -999...9999	Input drift: <0.1% / 20°C env. T.
	DC input (voltage)	0/10...50mV, Rj >10MΩ	High Range -999...9999 100 digits minimum	
	Auxiliary input (option)	CT current transformer (M3 only)	50 or 100mA input hardware selectable	Current visualization 10...200 A with 1A resolution and Heater break alarm
Operating modes	M1 : 1 single action PID loop or ON/OFF with 1 alarm M3 : 1 double action PID loop or ON/OFF with 1 or 2 alarms			
Control mode	Algorithm	P.I.D. with overshoot control or ON/OFF		
	Proport. band (P)	0.5...999.9%	OFF = 0	
	Integral time (I)	0.1...100.0 min		
	Derivative time (D)	0.01...10.00 min		
	Error band (M3 only)	0.1...10.0 digit		
	Cycle time	1...200 sec.		
	Dead band	-10.0...10.0		
	Relative cool gain	0.1...10.0		
	Cool cycle time	1...200 sec.		
	Overshoot control	0.01...1.00		
High limit	100.0...10.0% (heat) -100.0...-10.0% (cool)			
Hysteresis	0.1...10.0%		ON/OFF algorithm	
OP1 output	SPST relay N.O., 2A/250V~ for resistive load Triac, 1A/250V~ for resistive load			
OP2 output	SSR drive not isolated: 5V~, ± 10%, 30mA max SPST relay N.O., 2A/250V~ for resistive load			
OP3 output (M3 only)	SPST relay N.O., 2A/250V~ for resistive load Triac, 1A/250V~ for resistive load			
AL1 alarm (indicator with 2 alarms)	Hysteresis 0.1 ... 10.0% of range		M1 only	
	Active high	Absolute threshold, whole range		
Active low				
AL2 alarm	Hysteresis 0.1 ... 10.0% of range			
AL3 alarm (M3 only)	Action	Active high	Action type	
		Active low		
		Special function		
		Sensor break, Heater break, Loop break, Latching/Blocking		
Setpoint	Up and down ramps	0.1...999.9 digit/min (OFF = 0)		
	Low limit	from low range to high limit		
	High limit	from low limit to high range		
OP4 (option) PV or SP retransm. output	Galvanically isolated: 500V~/1min Resolution: 12bit (0.025%) Accuracy: 0.1%		In current 0/4...20mA 750Ω/15V max	
One-shot Fuzzy-Tuning	Depending on the process condition, the controller applies the best method		Step response	
			Natural frequency	

Input type	Scale range
RTD	-99.9...300.0 °C
	-99.9...572.0 °F
Pt100Ω a 0°C	-200...600 °C
	-328...1112 °F
T/C type L	0...600 °C
Fe-Const.	32...1112 °F
T/C type J	0...600 °C
Fe-Cu 45% Ni	32...1112 °F
T/C type T	-200...400 °C
Cu - CuNi	-328...752 °F
T/C type K	0...1200 °C
Cromel Alumel	32...2192 °F
T/C type S	0...1600 °C
Pt10%Rh-Pt	32...2912 °F
0/4...20 mA	Configurable engineering units mA, mV, V, bar, psi, Rh, ph
0/10...50 mV	
mV Custom scale	On request

Table 1 : PV input

## Special functions

To improve the instrument performance and to reduce the wiring and installation costs, two special functions are available:

### - Start-up

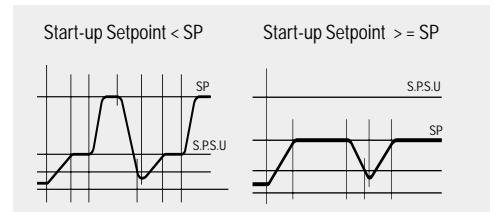

### - Timer



The use of these functions avoids additional device installation (e.g. external timer), therefore allowing a significant costs reduction.

Moreover there are:

- **Keypad lock/unlock** function, to avoid incorrect operator actions
- **Outputs lock/unlock** function, at any moment it is possible to stop the control action, but not the process variable display, without switching-off the power supply.

# Technical data

Features at env. 25°C	Description	
Ser. comm.s (opt.)	RS 485 isolated, Modbus/Jbus protocol 1200, 2400, 4800, 9600 bit/sec, two wires	
Aux. power sup. (option)	+18V- ±20%, 30mA max for external transmitter supply	
Operational safety	Measure input	Detection of out of range, short circuit or sensor break with automatic activation of the safety strategies and alerts on display
	Control output	Safety value (user enabled/disabled): 0%, 100% (M1) 0...100% (-100...100% for Heat/Cool mode) (M3).
	Parameters	A non volatile memory stores for unlimited time all the parameter and configuration values
	Password	A password protects the access to the instrument configuration and parameters
General characteristics	Power supply	100-240V~ (-15% +10%) 50/60Hz or 24V~(-25% +12%), 50/60Hz and 24V- (-15% +25%). Power consumption 2.6W max
	Safety	Compliance EN61010-1 (IEC 1010-1), installation class 2 (2500V), pollution class 2, class II instrument
	Electromagnetic compatibility	Compliance to the CE standards for industrial system and equipment
	Approval UL and cUL	File E176452
	Protection EN60529 (IEC 529)	IP65 front panel
	Overall dimensions	1/16 DIN - 48 x 48, depth 120 mm, weight 130g appr. Panel cut-out: 45 <sup>+0.6</sup> x 45 <sup>+0.6</sup> mm

## Electrical wirings

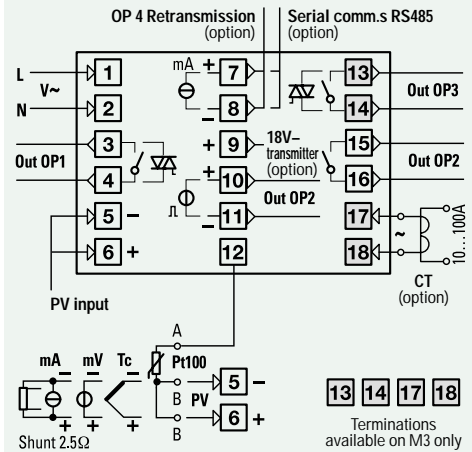

## Ordering codes

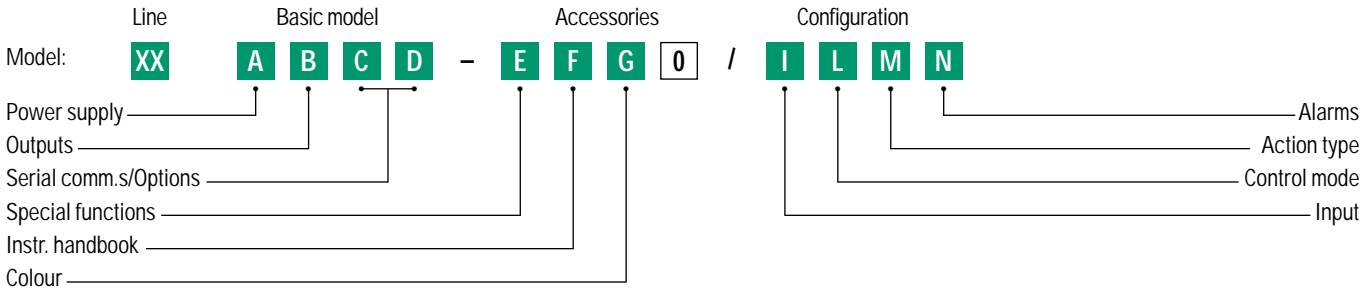

Line		M1	M3	C	D	
Controller-Indicator 48x48x120					<b>XX</b>	
Heat/Cool Controller 48x48x120					M1	
Power supply					M3	
100-240V~ (-15% +10%)					A	
24V~ (-25% +12%) or 24V- (-15% +25%)					3	
OP1 (OP3) output					5	
Relay		✓			B	
Relay-Relay			✓		0	
Relay-Triac			✓		1	
Triac		✓			2	
Triac-Relay			✓		3	
Triac-Triac			✓		4	
Serial comm.s	Options	M1	M3	C	D	
Not fitted	None	✓	✓	0	0	
	Current Transformer input (CT)		✓	0	3	
	Transmitter power supply + 18V	+ Retransmission	✓	✓	0	6
		+ CT	✓	✓	0	7
		+ Re-trans. + CT	✓	✓	0	8
RS 485	None	✓	✓	5	0	
Modbus/Jbus protocol	Transmitter power supply + CT	✓	✓	5	6	
		✓	✓	5	8	
Special functions		M1	M3	E		
Not fitted		✓	✓	0		
Start-up + Timer			✓	2		
Instruction handbook				F		
Italian-English (std)				0		
French-English				1		
German-English				2		
Spanish-English				3		
Front case colour				G		
Dark (std)				0		
Beige				1		

Input type	Range scale		I		
RTD Pt100 IEC751	-99.9...300.0 °C	-99.9...572.0 °F	0		
RTD Pt100 IEC751	-200...600 °C	-328...1112 °F	1		
TC L Fe-Const DIN43710	0...600 °C	32...1112 °F	2		
TC J Fe-Cu45% Ni IEC584	0...600 °C	32...1112 °F	3		
TC T Cu-CuNi	-200...400 °C	-328...752 °F	4		
TC K Chromel -Alumel IEC584	0...1200 °C	32...2192 °F	5		
TC S Pt10%Rh-Pt IEC584	0...1600 °C	32...2912 °F	6		
0...50mV linear	Engineering units		7		
10...50mV linear	Engineering units		8		
mV "Custom" scale	On request		9		
Output configuration		M1	M3	L	
P.I.D.	control OP1 / alarm AL2 on OP2	✓	✓	0	
	control OP2 / alarm AL2 on OP1	✓	✓	1	
	control OP2 / alarm AL2 on OP1	✓	✓	2	
On - Off	control OP1 / alarm AL2 on OP2	✓	✓	3	
	control OP2 / alarm AL2 on OP1	✓	✓	4	
Indicator with 2 alarms	alarm AL1 on OP1 / alarm AL2 on OP2	✓		5	
	alarm AL1 on OP2 / alarm AL2 on OP1	✓		6	
Heat / Cool action	control OP1-OP3 / alarm AL2 on OP2		✓	7	
	control OP1-OP2 / alarm AL2 on OP3		✓	8	
	control OP2-OP3 / alarm AL2 on OP1		✓	9	
Single control action type	Heat/Cool (M3) Safety (M1)	M1	M3	M	
Reverse (M1: AL1 active low)	Linear cool	0%	✓	✓	0
Direct (M1: AL1 active high)	On-Off cool	0%	✓	✓	1
Reverse (AL1 active low)		100%	✓		2
Direct (AL1 active high)		100%	✓		3
AL2 type and function		M1	M3	N	
Disabled		✓	✓	0	
Sensor break/Loop break (M3) alarm		✓	✓	1	
Absolute	active high	✓	✓	2	
	active low	✓	✓	3	
	active high	✓	✓	4	
Deviation	active high	✓	✓	5	
	active low	✓	✓	6	
Band	active out	✓	✓	7	
	active in	✓	✓	8	
Heater break by CT (if present)	active during ON output state		✓	9	
	active during OFF output state		✓	0	

If not differently specified the controller will be supplied with standard version

Model: M1 3000-0000 or M3 3100-0000